

DEVELOPMENT OF LOCAL POSITIONING SYSTEM FOR A PIPE-LESS PLANT

**Automation & Robotics
Group Project SS18**

Group Members:

Abdulrahman Abouelkhair(198803)
Medhini Rajagopal Balamurugan(198735)
Stefan Rottstegge(191455)
Stephan Vette(198907)

Supervisors:

Afaq Ahmad
Marina Rantanen-Mod er

Abstract

The pipeless plant at the Process Dynamics and Operations group is an experimental setup of Automated Guided Vehicles (AGVs) moving between various stations. The AGVs dynamically change trajectories in an operational mode based on a Model Predictive Control (MPC) scheme with the objective to get from one station to the other while at the same time avoiding each other. The current positioning system is based on pattern recognition where the system tracks each AGV based on a unique pattern of LEDs via a camera that overlooks the plant. The vision-based positioning system displays some flaws and should be replaced by a system more adapted to the actual operational environment of the experimental plant.

The project aimed at first evaluating different potential positioning systems, selecting one of them based on defined metrics. A proof-of-concept was developed based on the chosen technology for the experimental pipeless production plant in a model-driven fashion and the Radio-Frequency Identification (RFID) was chosen for further evaluation and implementation. The system detects RFID tags with a reader and an antenna. The reader receives the unique Identification (ID) and the RSSI (Received signal strength indication) of the tag which is being used for calculating the position of the robot.

For the estimation of the position part, the WiFi module then transmits the reader data through the local network, using TCP/IP communication. The system data is lastly received by a PC that represents the control hub of the plant through a framework implemented in C#. The algorithm which calculates the position of the AGV prompts for this data as position and/or orientation of an AGV that needs to be computed.

Contents

1	Introduction	7
2	Pipeless plant	9
2.1	Experimental pipeless production plant	9
2.2	Problems with the existing setup	10
2.3	Project objectives	10
3	Possible localization technologies for chosen application	11
3.1	Triangulation	11
3.2	Pattern Recognition	15
3.3	Map-Based Localization[1]	17
3.4	RFID	20
4	Principle of localization via Radio Frequency Identification technology	23
4.1	Radio Frequency Identification	23
4.1.1	RFID System	23
4.1.2	Working Principle	23
4.2	Trilateration	25
5	Hardware	27
5.1	RFID reader and antenna	27
5.2	RFID tag	28
5.3	Wifi Module	29
5.4	Hardware Setup	30
6	Simulation	32
6.1	Emulator	32
6.2	RSSI Measurements with real hardware	33
6.3	Simulation with emulated data	34
6.4	Results	34
7	Implementation	35
7.1	Communication	35
7.2	Initialization procedure	38
7.2.1	Recording and filtering data	42
7.2.2	Analysing data	42
7.2.3	Selection of correct distance related to RSSI	43
7.2.4	Estimation of initial position and orientation	45
7.3	Test setup	46
7.4	Results	48
8	Conclusion	50
9	Future work	51
9.1	Hardware	51
9.2	Software	51
10	References	52

11	Appendixes	54
11.1	Appendix A: Emulator RFID data (Matlab)	54
11.2	Appendix B: Receiving data from reader via Wifi (C#)	58
11.3	Appendix C: Initialization procedure (C#)	62
11.4	Appendix D: Initialization turn and recording Data(C#)	62
11.5	Appendix E: Filling Array(C#)	64
11.6	Appendix F: Checking for solutions in array(C#)	65
11.7	Appendix G: Position and orientation estimation(C#)	68
11.8	Appendix H: Initialization procedure 3(C#)	71
11.9	Appendix I: Initialization procedure 4(C#)	73
11.10	Appendix J: Initialization procedure 5(C#)	73
11.11	Appendix K: Initialization procedure 6(C#)	74
11.12	Appendix L: Initialization procedure 7(C#)	80
11.13	Appendix M: WiFi Initialization WeMos D1 Mini (Arduino)	82
11.14	Appendix N: Launch the communication)	82
11.15	Appendix O: Receiving data from RFID reader	84
11.16	Appendix P: Publishing tags IDs through the network	84
11.17	Appendix Q: Manual Configuration of the RFID reader	85
11.18	Appendix R: Communication Outlay	86

List of Figures

1	Existing setup	9
2	The ListOfFigures caption	11
3	The ListOfFigures caption	12
4	Implementation of passive triangulation	13
5	Ceiling with periodic patterns of lamps acting as landmarks.	15
6	Belief grid of the robot in the plant	16
7	Snapshot of the ceiling	16
8	The ListOfFigures caption	17
9	The ListOfFigures caption	18
10	The ListOfFigures caption	18
11	The ListOfFigures caption	18
12	The ListOfFigures caption	18
13	Passive RFID System	20
14	Active RFID System	20
15	Reader Tag	23
16	RFID System	24
17	Inductive Coupling	24
18	Overview Trilateration	26
19	RFID reader KTS Systeme RFIDM1356-001	27
20	RFID Antenna KTS Systeme PCBA1356_8	28
21	The ListOfFigures caption	29
22	Tags on the plant floor	29
23	The ListOfFigures caption	29
24	Robot Hardware Schematic	30
25	Hardware Schematic	30
26	Top of the Robot	31
27	Base of the Robot	31
28	Relation between RSSI and distance antenna to tag	33
29	RFID-WeMos Module Communication	35
30	WeMos Module Network Communication	36
31	Computer Network Communication	37
32	Different possible positions for one antenna position	38
33	Possible hazards/obstacles	39
34	Flow Chart: Initial procedure 360° turn	40
35	Test environment in GUI	40
36	Flow Chart: Analyzing initialization measurment points	43
37	Flow Chart: Selection of correct distance and most proper IDs	44
38	Computing the center of the robot	46
39	Orientation of robot in absolute angle	46
40	testing setup for initialization procedure	47
41	Estimated position in x-direction	48
42	Estimated position in y-direction	48
43	Estimated orientation	49
44	Communication Outlay	86

List of Tables

1	Pros and cons points of passive triangulation	14
2	Pros and cons points of active triangulation	14
3	Pros and cons points of Mobile Robot Localization based on Pattern Recognition	16
4	Pro and cons of Localization using Ultrasonic Sensor	19
5	Overview RFID systems	21

6	Pro and cons of active RFID system	22
7	Pro and cons passive RFID system	22
8	Relation between RSSI and distance antenna to tag (data)	33
9	Results Simulation	34
10	Filled initialization array after 360° turn	41
11	String preperation	42
12	Possible shapes of pattern	44
13	Positions of the IDs in the test setup	47

1 Introduction

In today's world, the development and implementation of the positioning system for the autonomous vehicle in a confined space remains to be a major issue and hindrance to a better control system. Though there exists many types of local positioning systems, the precision remains to be still a challenge. This problem becomes critical in a place of no global positioning system (GPS) access. This project aims at investigating various methods of indoor localization technologies and to develop a proof-of-concept for the existing pipeless plant setup.

In the past years students and researchers at the Process Dynamics and Operations group at the TU Dortmund have developed the pipeless plant with vision based positioning system which needs to be replaced to improve the accuracy of the estimation of the position. Both the old and newly implemented techniques are written in C# that sends the position update to the Python based controller code.

In this project, various potential positioning techniques were discussed and their pros and cons were compared. The different localization methods will be further discussed in section 3. The four different alternatives included a triangulation based methods for indoor applications, pattern recognition based method (such as QR-codes), map-based localization and RFID. After a thorough analysis of the listed technologies, RFID was chosen to be the ideal technique. It is a versatile technology with multiple application areas, e.g. access control, race tracking and positioning. Automated multi-agent systems are increasingly utilizing RFID for localization as the technology has been proven to have many advantages over vision based positioning systems. There are two potential ways to implement an RFID localization system namely active and passive as discussed in 4. The latter is based on comparatively many passive tags, uniformly placed, on the ground of the plant area and active readers on the AGVs. The latter option was chosen for the project based on cost efficiency, system scalability and from literature proven applicability.

An RFID system is made up of two parts: a tag and a reader. RFID tags are embedded with a transmitter and a receiver. The RFID component on the tags has two parts: a microchip that stores and processes information, and an antenna to receive and transmit a signal, which partly contains the unique ID of the tag. The hardware components which are added to the AGVs comprise an RFID antenna, an RFID reader and a WiFi module. Further hardware implementation is explained in section 7. The WiFi module then transmits the reader data through the local network, using TCP/IP communication. The system data is lastly received by a PC that represents the control hub of the plant through a framework implemented in C#. A TCP-Client was established in the C# framework in order to handle incoming RFID data. The WiFi-module continuously sends data and the algorithm calculating the position of the AGV prompts for this data as position and/or orientation of an AGV that needs to be computed.

The implemented positioning algorithm requires the ID and the RSSI of at least three RFID

tags to calculate the position of the antenna. The RSSI gives a relation between the detected tag and the distance to it, in other words, a radius. The system has a record of the position of each tag and the ID of each tag hence holds information about the uniquely defined position of the tag. With three positions and the three corresponding radii, one can use trilateration to compute the position of the antenna. This concept was developed into simulation which would be discussed in section 6. The experiment based results will be explained in section 7. Based on the experiment, conclusion and future work are given in section 8 and 9 respectively.

2 Pipeless plant

In chemical industry, pipeless plants are used due to its high flexibility level. In these type of plants, AGVs are used to transport the vessel from one processing station to another. Thus, for each and every batch, the AGV transport the vessel to various stations to create an end product, making the pipeless plant multi-product and multipurpose chemical production. In this way, piping and the associated cleaning is eliminated, thus aiding in cost and energy efficiency.

2.1 Experimental pipeless production plant

The pipeless plant framework in the TU Dortmund, developed by the Process Dynamics and Operations Group (DYN), consists of four AGVs, two color stations, one mixing station and one storage station. Each station has a role in producing batch of plaster art, for example mixing or filling the product in the vessel. The stations and the AGVs are controlled by a Programmable Logic Controller(PLC). The vessel on the AGV is moved from one station to another based on the schedule to produce a batch. Regarding the positioning system, the plant uses a camera to identify the LED pattern on the AGV. Each AGV has a unique pattern that distinguishes it from another.

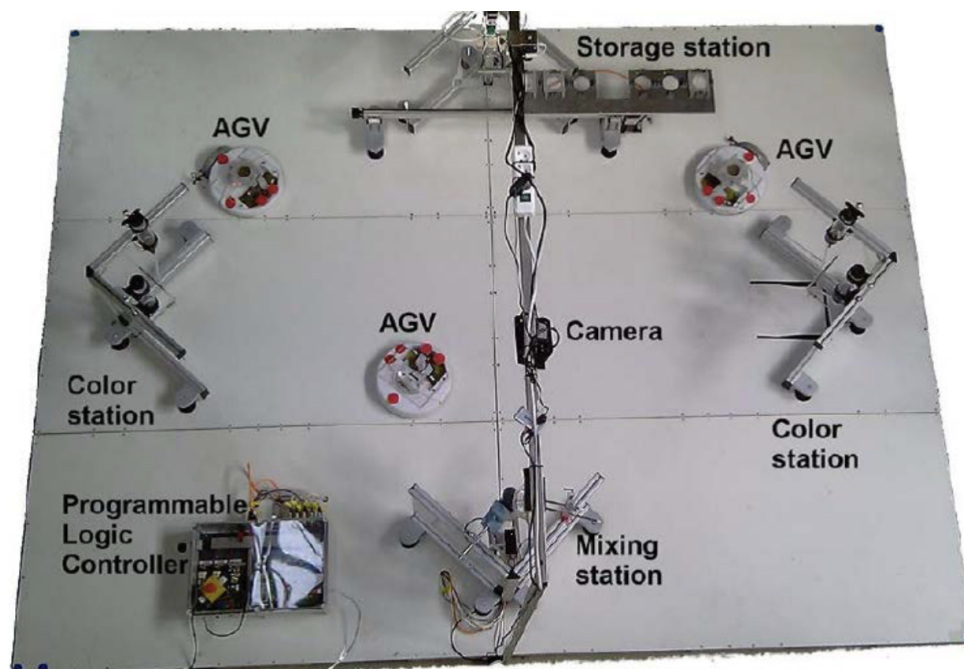

Figure 1: Existing setup

2.2 Problems with the existing setup

Since the existing setup uses vision based positioning system, the plant suffers various disadvantages as described below:

- During bright day-light conditions, no position is updated by the camera. This is due to the fact that the threshold of the sunlight and the LED on the AGV becomes equal that the camera fails to detect any pattern, thus affecting the whole system efficiency.
- The camera suffers the so called fish-eye camera lense problem, meaning that the position error is proportional to distance from the center of the image. This is caused by the distortion a wide angle lens.
- The restriction of usage of incoming information from the camera during software implementation.
- The percentage error and the processing time increases with the increase in number of robots to be localized thus affecting the controller input.

All these cons added up together cause a deterioration in the accuracy of the position of the AGV, which in turn affects the controller leading to a drop in system efficiency.

2.3 Project objectives

The disadvantages of the vision based positioning systems as discussed above leads to the urge for creating a localization that overcomes all the cons already suffered.

This projects aims to research about alternative positioning system and to evaluate with the selected technique by simulation. The ultimate goal is to develop a positioning system with improved position precision and to compare and develop practical proof-of-concept.

3 Possible localization technologies for chosen application

Since the main aim of the project is to improve the positioning system of the existing setup, several other techniques were discussed, ending up in four methods namely triangulation, pattern recognition, radio frequency identification, map-based localization. The pros and cons were listed and the mentioned techniques were compared. The following section deals with a brief description of the above-mentioned techniques.

3.1 Triangulation

Since the plant has a specified size in which the location of multiple objects has to be performed the method of triangulation is one promising technique in which research was made. Triangulation was already a common principle of measurement in the 18th century and it is divided into active and passive triangulation. Passive triangulation is a geometrical method based on two measurement stations which positions are known exactly. At these two measurement points angles of the desired point in space are measured to compute the localization in the specified coordinate system (x, y, z) with trigonometrical formulas. With respect to the system setup used in the 18th century nowadays two cameras are installed to perform a geographical method of 3D object-data estimation as shown in fig. 2 [2].

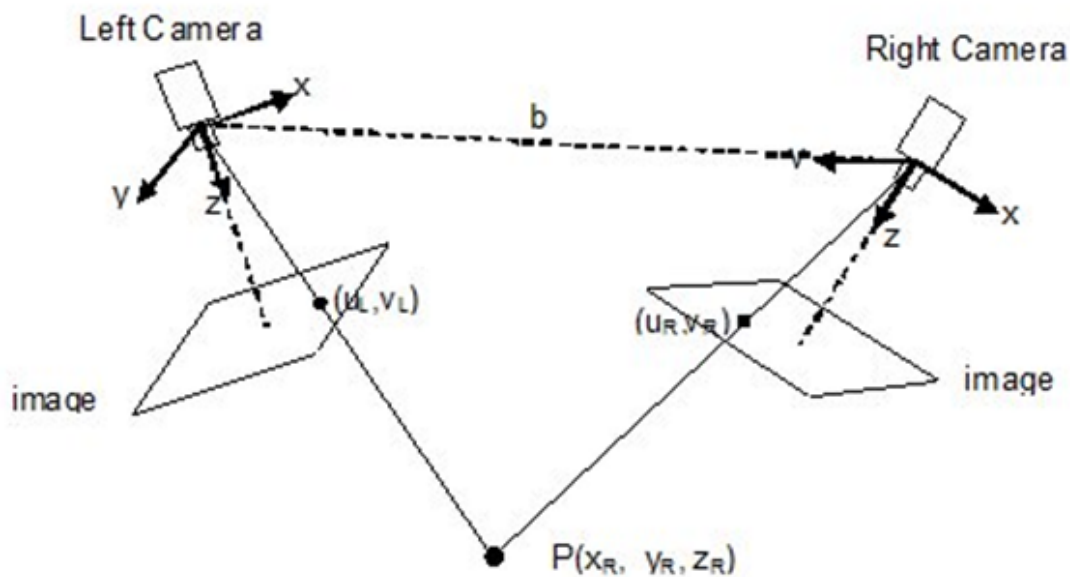

Figure 2: Passive triangulation setup with two cameras ¹

¹Source: <https://arxiv.org/abs/1410.2535>

To solve the problem of position estimation, it is necessary to know the parameters of the left and the right camera visualized in fig. 2. In theory the triangulation is trivial, since each and every point of the images of the respective cameras maps to a line in 3D space. If a pair of corresponding points, in the case of the pipeless plant an AGV is found, the projection of a point x in 3D space can be computed. Active triangulation in comparison to passive triangulation needs one camera and at least one source of structured light (e.g. Laser). The geometrical location and orientation of the camera and light source in space need to be known. Two possible setups with either a laser point or a stripe as structured light are shown in fig. 3 [3][4].

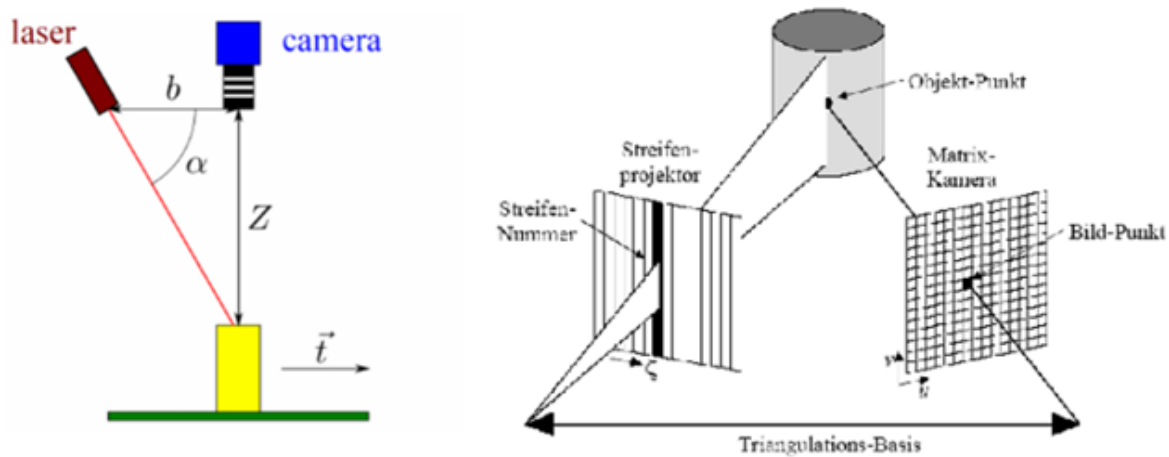

Figure 3: Active triangulation ²

To solve the active triangulation problem, the structured light has to point an object which location is desired to estimate. If this point is found on the 2D image of the camera, a triangulation is performed. Basic trigonometrical formulas [5] use the properties and parameters of the camera and light source to estimate the position of the AGV.

²Source: <https://www.tuhh.de/ft2/wo/Scripts/Videometrie3D/Prinzip3DVideometrie.pdf>

Implementation

One possible way to implement a solution for the passive triangulation is to attach 2 high resolution cameras with USB 3.0 on two edges of the plant as shown in fig. 4.

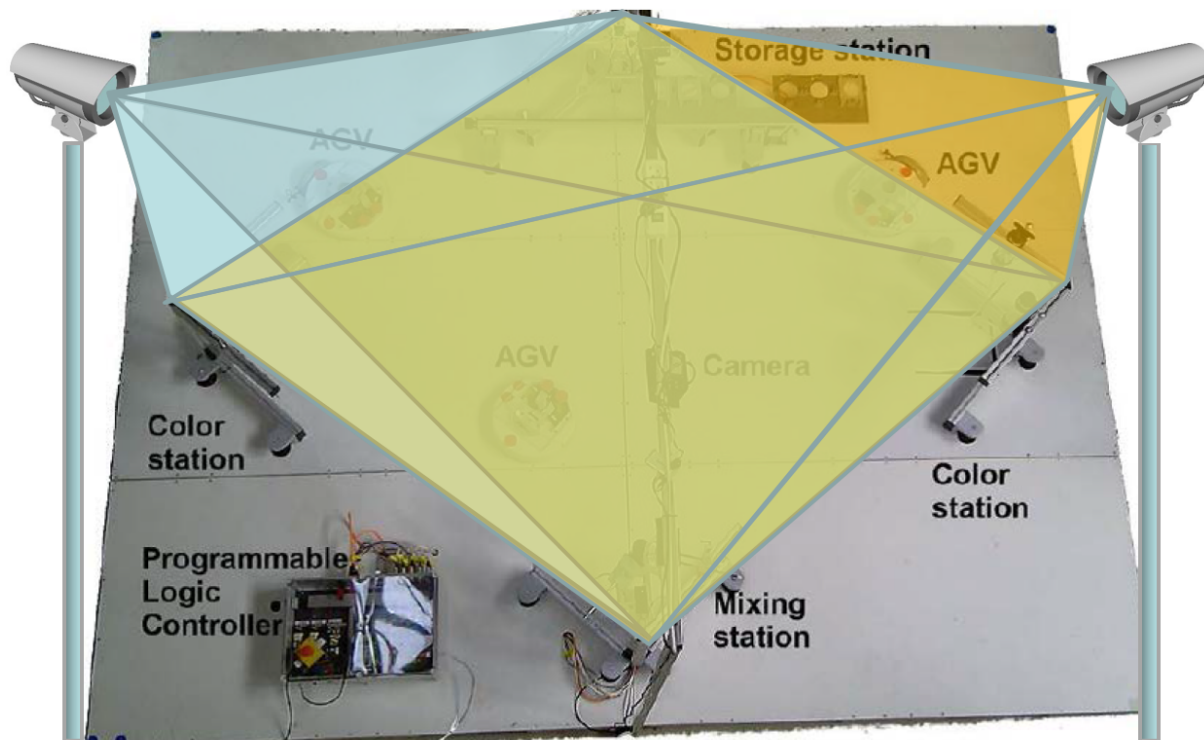

Figure 4: Implementation of passive triangulation

1

The left and right camera are sequentially taking pictures which are transmitted to the plants computer where the image processing takes place.

Based on the research made, two tables with advantages and disadvantages of the two triangulation systems were created.

Passive Triangulation	
Pro	Con
Upgrade to USB 3.0 for faster data transmitting possible	Light dependent
Upgrade to a camera with higher resolution to reduce measurement error possible	New concept of orientation may be needed
No Fish-Eye-Lense problem	Limited range of observation
Low cost	

Table 1: Pros and cons points of passive triangulation

Active Triangulation	
Pro	Con
Upgrade to USB 3.0 for faster data transmitting possible	New unknown laser technology is needed
Upgrade to a camera with higher resolution to reduce measurement error possible	High costs for several lasers (one per AGV)
Easy detection of laser points on camera image	Laser needs to move while AGVs are moving
	Limited range of observation
	Light dependent

Table 2: Pros and cons points of active triangulation

3.2 Pattern Recognition

In this type of localization, estimation of the robot is done in indoor environments using only on-board sensors, namely a web-cam and a compass [6]. The ceiling of the plant is constructed with a pattern of static landmarks whose positions are known a priori as shown in fig. 5. All landmarks are indistinguishable from each other and might additionally be distributed along the ceiling in a periodic pattern. The landmark attached to the ceiling can be lights, QR codes, sensors or other reference points. The ceiling is used since it is immune to changes. A camera is installed on the robot, which takes snapshots of the ceiling which can be seen in fig. 7. The robot pose relative to the landmark is calculated with the help of the distance of the landmark to the center of the image and its angle relative to the direction of the robot motion. An Inertial measurement unit(IMU) is additionally used to give the absolute orientation of the robot in the plant. The Markov Localization (ML) algorithm is used to estimate the belief grid of the robot position inside the environment.



Figure 5: Ceiling with periodic patterns of lamps acting as landmarks.

Implementation

The goal is to compute the pose of a mobile robot inside an indoor environment using a camera and an IMU. As mentioned, ML is used to create a belief grid of the robot in the plant environment. This is done with the help of the snapshots of the ceiling taken by the camera. As seen in the fig. 6, the blue and black areas have lower belief and green and yellow areas have higher

belief. The obtained pattern is evaluated and based on the pattern, the position of the robot is estimated. Thus with the help of the camera and the IMU, both the position and orientation is obtained.

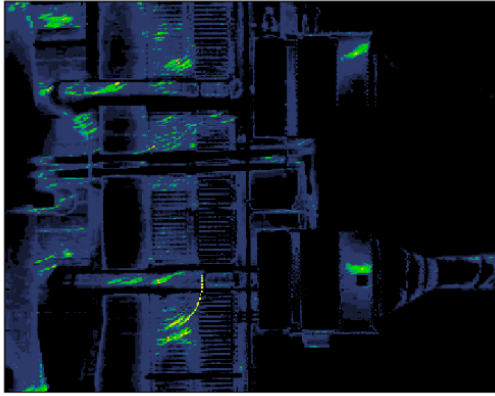

Figure 6: Belief grid of the robot in the plant

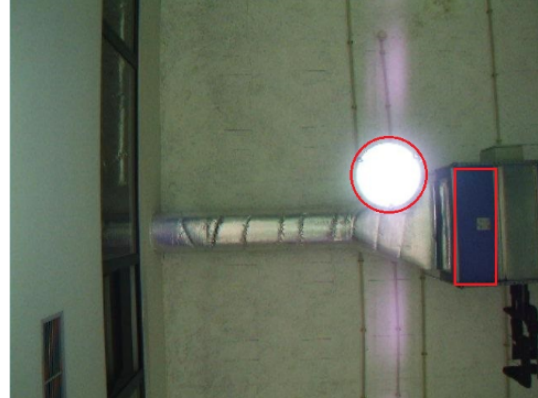

Figure 7: Snapshot of the ceiling

Based on the research, the advantages and disadvantages of Mobile Robot Localization based on Pattern Recognition are created.

Pro	Con
The ceiling is usually immune to changes as a reference and implement landmarks on the ceiling itself	Complex and many changes have to be added to the plant
No Fish-Eye-Lense problem	Cost intensive
	Light dependent

Table 3: Pros and cons points of Mobile Robot Localization based on Pattern Recognition

3.3 Map-Based Localization[1]

Adaptive Monte Carlo Localization (AMCL) is a probabilistic localization system for a robot moving on a two dimensional surface. It implements the adaptive (or KLD-sampling) Monte Carlo localization[7][8] approach, which uses a particle filter to track the position of a robot against a known map. Laser and Odom scans are taken in a laser-based map. With these

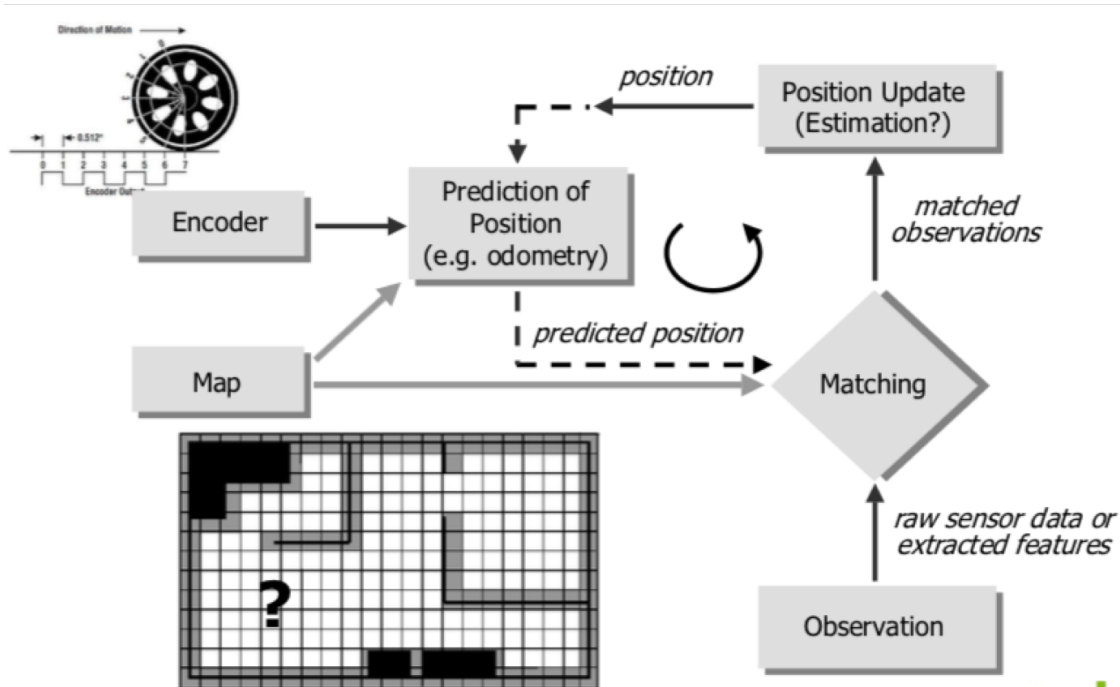

Figure 8: Adaptive Monte Carlo localization ¹

Information output positions are estimated like seen in fig.8. On startup, AMCL initializes its particle filter according to the parameters provided. Note that, because of the defaults, if no parameters are set, the initial filter state will be a moderately sized particle cloud centered at (0,0,0).

Implementation

To implement such a technique a global and local map should be created as shown in fig. 9 and fig. 10, In the following steps the localization of a robot based on a map can be seen.

- SLAM (Simultaneous Localization and Mapping) is a technique used in mobile robotics in which a robot builds a map of an unknown environment, while keeping track of its localization in this environment at the same time.

¹Source: www.moodle.tu-dortmund.de/mobile-robots

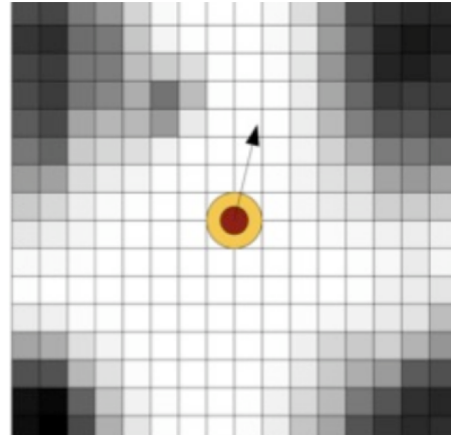
Figure 9: Global Map ¹Figure 10: Local Map ¹

- Adaptive Monte Carlo Localization

The goal for this algorithm is to determine the position of the robot on a given map of the environment.

At every time t the algorithm takes as input the previous prediction $X_{t-1} = \{x_{t-1}^1, x_{t-1}^2, \dots, x_{t-1}^M\}$ as an input, an actuation command u_t , and data received from sensors z_t ; and the algorithm outputs the new prediction X_t .

- Orientation Correction

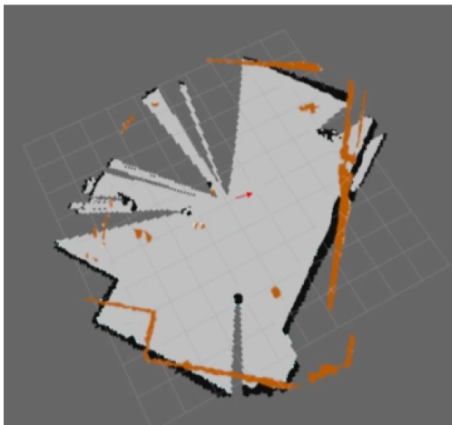
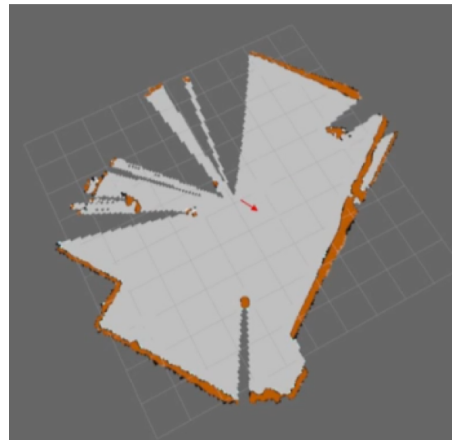
Figure 11: Robot Orientation ¹Figure 12: Correction with global map ¹

Initially the robot assumes a position as shown in fig.11, and as it moves it begins to

¹Source: www.moodle.tu-dortmund.de/mobile-robots

re-correct it's estimated orientation using the static obstacle with the global map as a reference (see fig. 12).

Based on the research made, two tables with advantages and disadvantages of the two Map-Based Localization systems are created.

Using Ultrasonic Sensor	
Pro	Con
Cheaper than the other localization techniques with €3 per each Ultrasonic sensor	Multiple Ultrasonic sensors need to be installed on a single robot due to very small scan angle ranging 30°
Easy installation of the sensors on the robot due to small size	A plant installation with similar landmarks causes localization error using AMCL
Ultrasonic sensors have faster feedback than the previous camera based localization system	Large plant size causes high computational effort for AMCL
Ultrasonic sensor has large scan range of 4.5 meters	Robots should start at every launch from static home position
Different map based localization algorithms are available	

Table 4: Pro and cons of Localization using Ultrasonic Sensor

3.4 RFID

One of the possible solutions to solve the challenging problem of indoor localization is the use of the Radio-frequency Identification (RFID) technology. The main areas of this technology is indeed "supply chains, transport, manufacturing, personnel access, animal tagging, toll collection" [9], but also has become popular in localizing objects and persons. Where in the main applications only the identification has to be realized, also the strength of the signals is important to estimate the position of a certain object.

The main idea of those systems is that a reader detects a tag and reads its information. The technology can be divided into three main types: passive, semi-passive and active systems. A passive system, like it is been shown in fig. 13, consists of a reader, which is connected to an antenna and a computer and a passive tag.

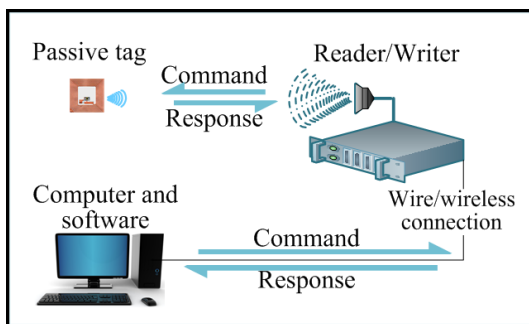

Figure 13: Passive RFID System ²

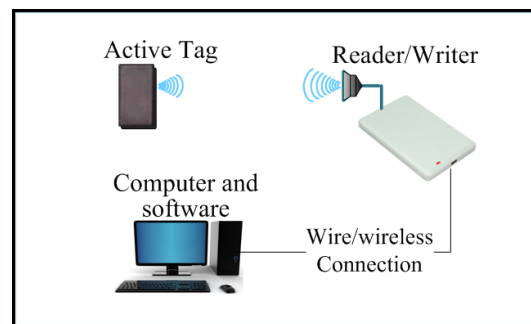

Figure 14: Active RFID System ²

The system is called passive, because the power supply is realized by the radio signal of the reader. In case where the tag is in the reading range of the reader, the tags get enough power to send predefined information (for example ID) back. The active system (see fig.14) in comparison has an active tag which has an own power supply. The semi-passive tag has a build-in battery that the tag has more power to communicate, but is not used to generate radio frequency signals. Another classification of RFID systems is the frequency of the radio waves. It can reach from 0.135 MHz (Low Frequency) to 5875 MHz (Super High Frequency). The table 5 gives an overview about the systems related to reading ranges, reading rates and the ability to read near metal or water.

It can be seen that the passive systems have a smaller reading range than the active systems, but have a bigger data rate. Another important aspect in taking the best choice is, that passive tags are cheaper (around 0.20 €) than active tags (around 9.00 €).

²Source: Overview of RFID-Based Indoor Positioning Technology [9]

	LF	HF	UHF	SHF
FR (MHz)	< 0.135	3~28	433-435, 860-930	2400~2454 5725~5875
RR(P)	≤ 0.5 m	≤ 3 m	≤ 10 m	≤ 6 m
RR(A)	≤ 40 m	300 m	≤ 1 km	≤ 300 m
TRR	Slower	←————→		Faster
ARMW	Better	←————→		Worse
FR: Frequency Range RRP: Typical Reading Range of Passive Tags RRA: Typical Reading Range of Active Tags TRR: Tag Reading Rate ARMW: Ability to Read near Metal or Water				

Table 5: Overview RFID systems ³

Implementation

There are mainly two different ways to realize a localization system of the AGVs in the pipeless plant. Based on the fact that the plant has a size of 3 by 4 meter, the tracking can be carried out with a passive system in which a couple of passive tags on the floor can be used as landmarks. In this case the reader plus the antenna would be placed on the AGV and localize with the help of the detected tags. The other systems consists of three or four readers in each corner of the plant and an active tag placed on each AGV.

³Source: Overview of RFID-Based Indoor Positioning Technology [9]

Based on the research made, two tables with advantages and disadvantages of the two RFID systems were created.

Active RFID system	
Pro	Con
Light independent	Prototype more expensive (3 reader + active tags)
Scalable solution	Datarate is related to the amount of detected tags a the same time
Localization only has to be realized in a bigger area - medium accuracy	Anticollision need, cause more AGVs are used at the same time
Wired communication between reader and computer possible	Signal strength can be influenced by environment (metal or water)
Simple algorithm (Trilateration)	

Table 6: Pro and cons of active RFID system

Passive RFID system	
Pro	Con
Light independent	Communication between AGV and computer has to be realized
Scalable solution	Data rate is related to the amount of detected tags a the same time
Localization only has to be realized between four tags (small area) - high accuracy	Anticollision need, cause more tags are detected at the same time
Simple algorithm (Trilateration)	
Prototype cheap (1 reader + passive tags)	

Table 7: Pro and cons passive RFID system

4 Principle of localization via Radio Frequency Identification technology

4.1 Radio Frequency Identification

After deep analysis of different localization methods the Radio Frequency Identification[10][11] was chosen due to its various advantages. This technology involves a reader and a tag which is placed on the object to be tracked. The reader is continuously sending the radio waves, and when the tag is within the range of reader, it sends a feedback signal to the reader as shown in fig. 15. The reader can track multiple tags at the same time.

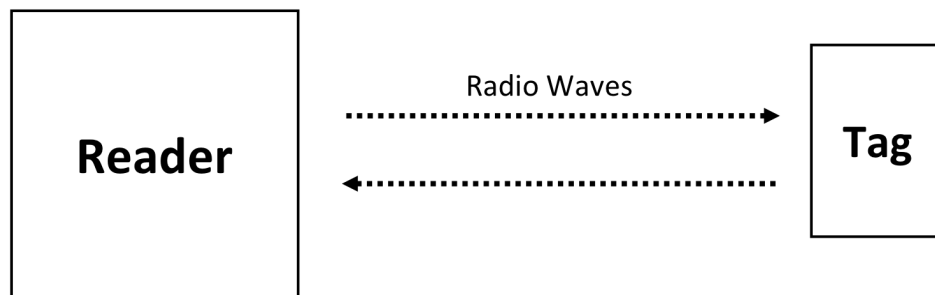

Figure 15: Reader Tag

4.1.1 RFID System

Regarding the tags as shown in fig.16, it can be either

- Active tag which has its own power supply
- Passive tag which relies on the radio waves as its source of energy that come from the reader
- Semi-passive tag which has power supply, but for transmitting the feedback, it relies on the signal coming from reader

4.1.2 Working Principle

The RFID consists of three main parts:

- A Generator which generates the radio waves
- A signal detector which receives the feedback from the tag
- Micro-controller which processes the information from the generator and the detector

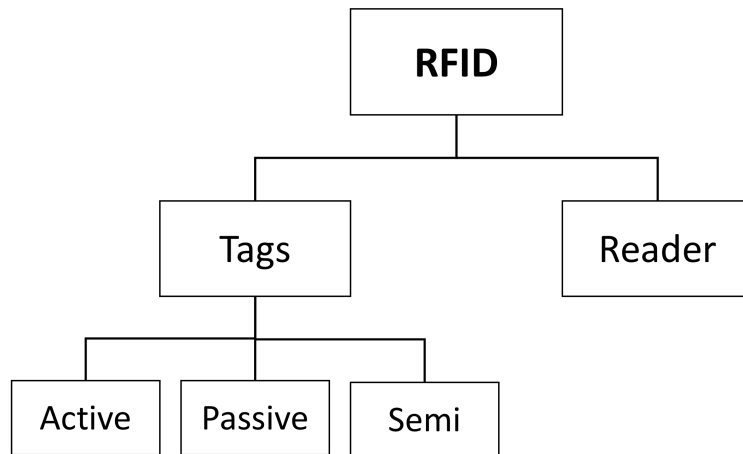

Figure 16: RFID System

The tags consists of:

- Transponder: that receives radio waves and sends the feedback
- Rectifier Circuit: which stores the energy coming from the wave across the capacitor, and this energy is used as a power supply for the controller as well as the memory

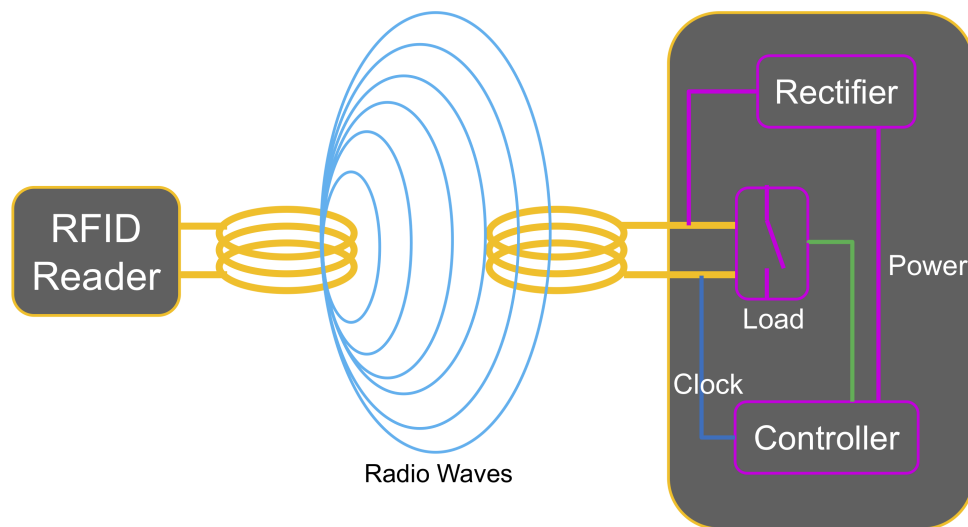

Figure 17: Inductive Coupling

The whole process of sending the information between the tag and the reader is based on principle of "Inductive coupling" as shown in fig. 17. The reader is continuously sending radio

waves with particular frequency. In this case, the reader and tag should be within the range of the frequency. The field which is generated by the reader is used coupling antenna of the tag, and due to the mutual coupling, the voltage is induced across the coil of the tag. The voltage is rectified and used as power supply for the controller and derive synchronization clock for the controller.

When the load circuit is connected to the coil, the current starts flowing through it. Therefore, when the load is switched on and off, the current will be turned on and off respectively leading to the induction of particular voltage in the reader. This method of switching the load is called load modulation. Thus, with the help of load modulation with respect to the data stored in the tag, the value of the induced voltage can be modified. Which leads to the generation of modulation on carrier frequency, thereby sending the data to the reader.

4.2 Trilateration

Trilateration is a method to compute the intersection point P of three circles/spheres. For this, it is necessary to know the three center of the circles/spheres plus their corresponding radii. The basic idea to estimate the intersection point is to use the mathematical description of a sphere:

$$r^2 = (x - x_1)^2 + (y - y_1)^2 + (z - z_1)^2 \quad (1)$$

where $(P_n = (x_n, y_n, z_n))$ is the center of the sphere [12]. A few assumptions can be made to simplify (1) for a flat floor/ 2D space. First of all, the z-component of all spheres can be neglected. Another assumption is to define the origin of the first circle as the center of the coordinate system, the second along the x-axis with an distance (d) and the third shifted in x-(i) and y-direction (j), which is illustrated in following fig. 18.

With known positions of the center of the circles d, i and j can be computed in the following way[12]:

$$d = |P_2 - P_1| \quad (2)$$

$$e_x = \frac{1}{d}(P_2 - P_1) \quad (3)$$

$$a_x = P_3 - P_1 \quad (4)$$

$$i = e_x \cdot a_x \quad (5)$$

$$a_y = (P_3 - P_1) - i * e_x \quad (6)$$

$$e_y = \frac{a_y}{|a_y|} \quad (7)$$

$$j = e_y \cdot a_x \quad (8)$$

It has to be notice that P_1, P_2 and P_3 are 2D vectors, which represents the x- and y-coordinate of the points.

After obtaining these values, the relative distance from the origin of the coordinate system can

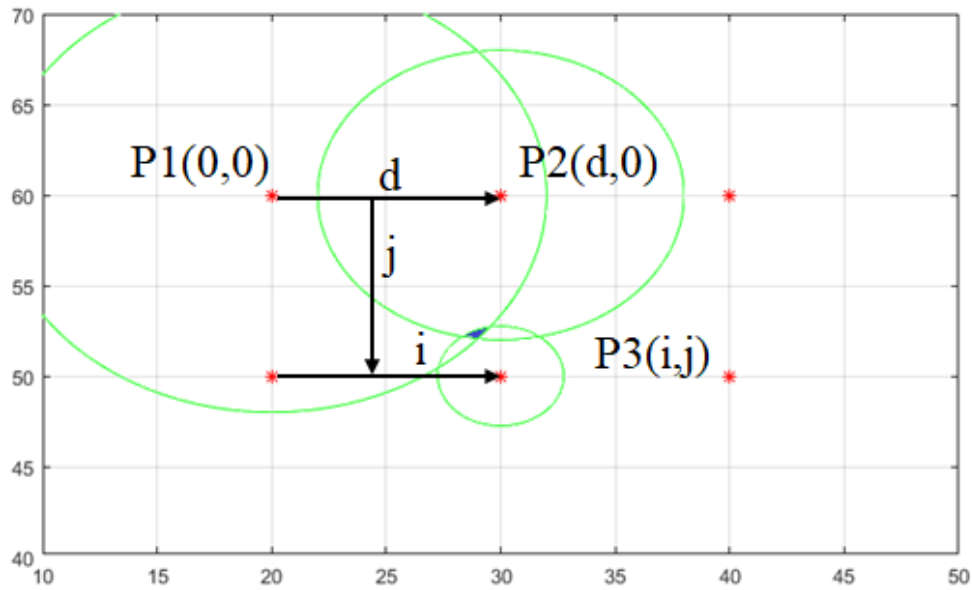

Figure 18: Overview Trilateration

be computed with the help of (1) and the center of the circles $P_1(0,0)$, $P_2(0,d)$ and $P_3(i,j)$ as follows:

$$x_t = \frac{r_1^2 - r_2^2 + d^2}{2 * d} \quad (9)$$

$$y_t = \frac{r_1^2 - r_3^2 + i^2 + j^2}{2 * j} - i * \left(\frac{x_t}{j} \right) \quad (10)$$

The absolute position of the intersection point is computed in following way:

$$P = P_1 + e_x * x_t + e_y * y_t \quad (11)$$

It can be seen, that those equations are using the first two points plus radii to estimate the x-coordinate, while the first and third point plus the computed x-coordinate are used to estimate the y-coordinate.

5 Hardware

5.1 RFID reader and antenna

The RFID reader from KTS Systeme (see fig.19) is a HF Modul (frequency around 13.56 MHz). It contains a full-fledged microcontroller with a high-performance RFID transceiver Integrated Circuit (IC). It has a 1.27 mm pitch pin-headers for Through Hole Technology (THT) mounting. The connection to an external antenna can be realized via a single ended 50 Ω connection or via pin header U.FL. jack, which was used in this project.

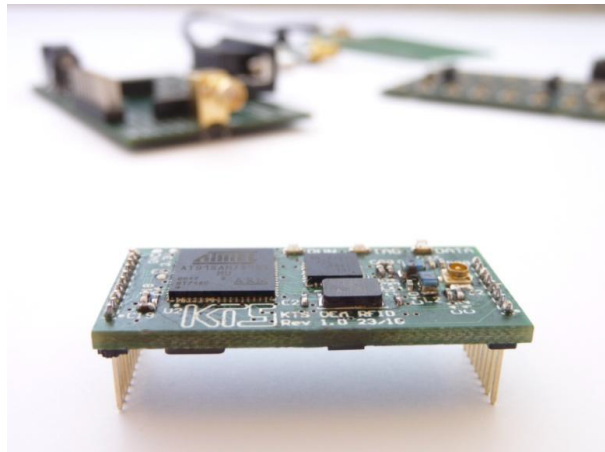

Figure 19: RFID reader KTS Systeme RFIDM1356-001

The communication to other devices is realized via a Universal Asynchronous Receiver-Transmitter (UART) compatible serial interface via pin 6 (RX) and 7 (TX). The power supply is a 5 V DC connection via pin 1 (VCC) and pin 10 (GND). The reader is standardized to ISO 15693 and ISO14443A/B and has the overall dimensions 36 x 16 x 4 mm [LxWxH][13].

The reader has three LEDs:

- Green: Run - Lights when reader receives power
- Yellow: Tag - Lights when a tag is detected
- Red: Data - Lights when data transfer to or from a tag

To configure the reader, KTS Systeme also provides a software (Tag2Image) for free. The reader was configured to scan the environment in an automatic anti collision mode (AT+Scan=AC,RSSI). Anti collision means that multiple tags can be detected at the same time and is highly important in this project. The output of the scan is a continuous information of the Identification (ID) and the RSSI of the detected tags. For example: SCAN:+UID=E00402000018313E,+RSSI=7/6 means that the tag with the ID (in hex)

E00402000018313E was detected with a RSSI of 7/6. The first number of the RSSI (in this example 7) is the value for the main channel. The second number (for this example 6) is for the auxiliary receiver channel and is almost similar with the first one, but always smaller. In this project only the first number of the RSSI was used, because they are almost the same. The RSSI is an integer value from 0 to 7 and gives an information about the distance between the antenna and the detected tag. 0 stands for the maximum reading range which was mentioned to be around 15 cm. A detailed relation was obtained through experiments during the project and will be explained later in this report. An AT Command Reference Guide is also available on <http://rfid.kts-systeme.de/downloads/>.

The antenna (fig. 20) is a HF PCB Antenne (PCBA1356_8) also from the company KTS Systeme. It has a dimension of 80 x 80 mm. The connection to the reader is realized by a SMA jack and has a self-impedance of 50Ω . The antenna is designed for passive tags in a frequency range around 13.56 MHz and has a maximum power of 1W.



Figure 20: RFID Antenna KTS Systeme PCBA1356_8

The antenna and the reader are connected with a SMA to U.FL. adapter cable.

5.2 RFID tag

The tag used in the prototype is of paper type (see fig.21) due to its added advantages as follows:

- The tags are cheap costing 18 cents each.
- It doesn't require power supply.
- The tags are compact.
- The implementation in the time of plant extension is simple.

It's working principle is based on inductive coupling with an operating frequency of 125-135 kHz and a range of 10cm. The tags are fixed on the floor at known location as shown in fig.22.

Figure 21: Paper Tag ¹

Figure 22: Tags on the plant floor

5.3 Wifi Module

The WiFi module used is from WEMOS Co.[14].It is a mini WiFi board with 4MB flash based on ESP-8266 which is a WiFi microchip with full IP/TCP stack and micro-controller (see fig.23).

Figure 23: WeMos D1 Mini WiFi Module ²

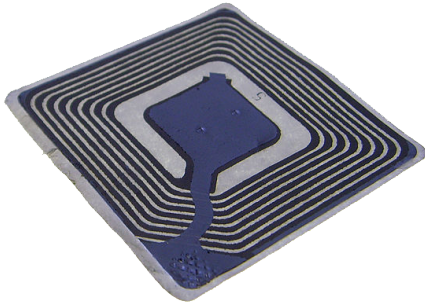
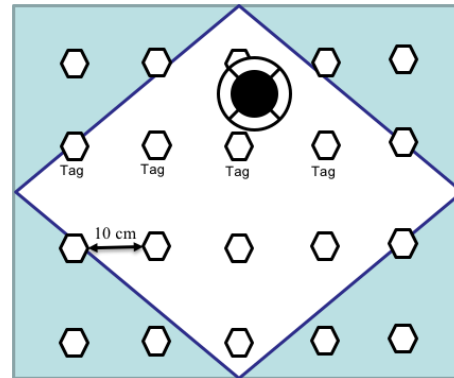
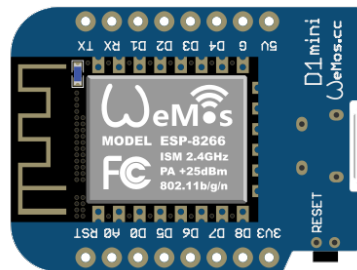
The WeMos module has the following features:

- 32-bit RISC microprocessor core running at 80 MHz
- External QSPI flash of 4 MB
- IEEE 802.11 b/g/n Wi-Fi
- 16 GPIO pins
- UART on dedicated pins, plus a transmit-only UART can be enabled on GPIO2
- 10-bit ADC and I^2C (software implementation)

¹Source: www.kurzweilai.net/scientists-print-cheap-rfid-tags-on-paper

²Source:www.github.com/mcauser/Fritzing-Part-WeMos-D1-Mini

5.4 Hardware Setup

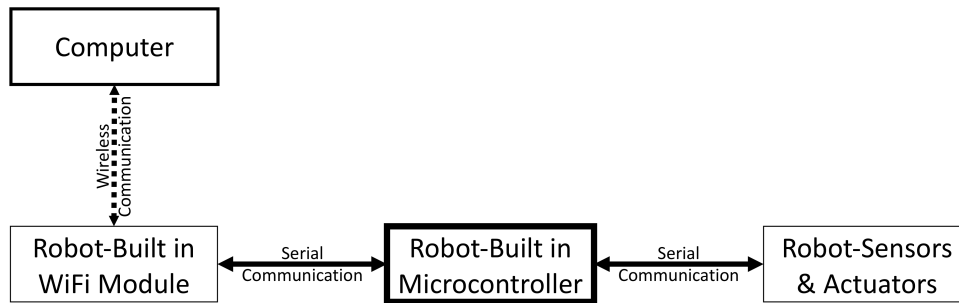

Figure 24: Robot Hardware Schematic

The built-in Micro-controller on the robot receives the sensor data and sends commands to the actuators via serial communication using its first UART pins. (TX/RX) is the process of sending and propagating an analogue or digital information signal over a physical point-to-point wired connection. It uses its second UART pins to communicate with the built-in WiFi Module. The built-in WiFi Module sends the received sensors data to the Computer and sends the received commands from the computer to the robot micro-controller via Wireless communication (see fig.24). Due to its less complexity, more flexibility and that the robot's in built micro-controller

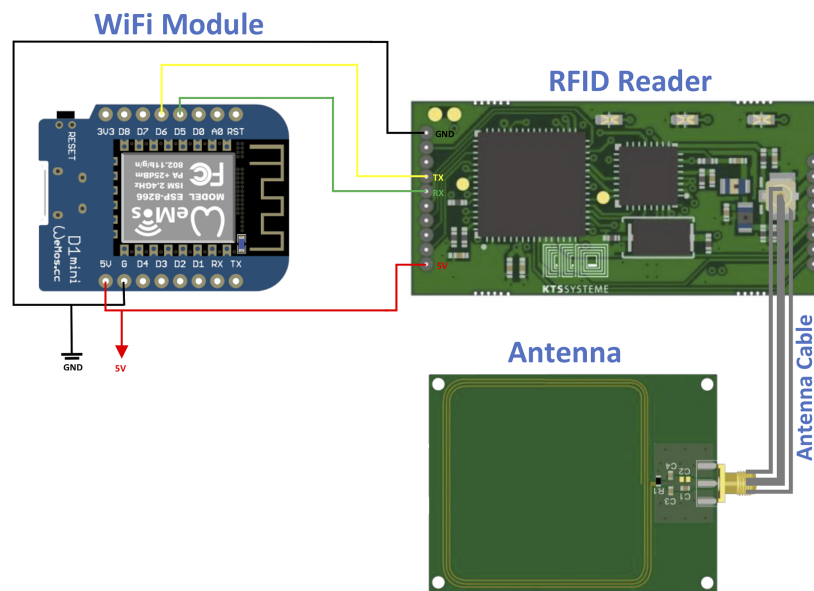

Figure 25: Hardware Schematic

UART pins are in use, a new communication setup was developed for the RFID reader to send

the data from the robot to the computer in parallel to the robot hardware setup. As shown in fig.25) the RFID reader is connected directly to the built-in micro-controller of the WeMos WiFi Module via serial communication sending it the tags IDs. The WeMos WiFi Module sends the received data through the network. The RFID reader is connected to the antenna which sends and receives the radio waves via SMA antenna cable.

The RFID reader as well as WeMos Module are placed on the top of the robot while the Antenna is fixed to the robot base such that the radio waves would be in direct contact with the tags on the floor.



Figure 26: Top of the Robot



Figure 27: Base of the Robot

6 Simulation

The simulation was carried out to answer important design questions before the real implementation phase. Furthermore, artificial RFID reader data was created to test and simulate the algorithm, which will be explained in chapter 7.

To answer the design questions, the simulation has the following parameter (Appendix 11.1 Line 1-50):

- the size of the simulation space
- distance between the tags
- distance between the first/last row/column of tags and the boarder of the simulation space
- diameter of the robot
- position of the antenna related to the origin of the robot
- the relation between RSSI and the distance antenna and tag
- initial start position and orientation
- difference between the measurement points of the initialization procedure
- optional: cycle time and speed of the robot (for another procedure)
- logging parameter (look of the logged text file)

Foregone tests lead to a distance between the tags of 10 cm. This was founded on the fact that in this case at least four tags are detected at the same time (maximum reading range of 14 cm). In this case around 121 tags are needed for every square meter. This is a realistic number of tags for a small plant size, because it will lead to around 800 tags for the whole plant.

6.1 Emulator

To create artificial RFID reader data, the emulator must write all detected tags together with information about the measuring point into a text file. During the initialization procedure, which was the main focus in this project, the robot turns around 360° and makes measurements every 45° .

The emulator computes the distance from the center of the antenna to the neighbouring tags at each measurement point. If a tag is closer than the maximal reading distance, the emulator writes the detected ID of the tag together with its RSSI into the text file.

The RSSI is, as explained earlier, an integer value from 0..7. 0 defines in this case a distance from 14 to around 10 cm from the antenna to the tag. In the first version of the emulator the RSSI mentioned a consistent increasing of the RSSI while the distance between the tags and the antenna gets smaller [15].

During own measurements it has been found out that this relation is inconsistent. Therefore the second version of the emulator was updated and creates more realistic data.

6.2 RSSI Measurements with real hardware

The relation of the RSSI is not just related to the distance between the antenna and the tag. It also depends on the orientation of the plain of the antenna and the tag. The tests with the real hardware was performed in a setup where the tags were placed on a floor and the antenna was parallel to the floor at a height of 1.5 cm. The reason for this was the fact that the antenna should be placed directly under the robot. Table. 8 and fig. 28 present the results of the measurements.

RSSI (Received Signal Strength Indicator)	0/0	1/1	2/2	3/3	4/4	5/5	6/6	7/7
Maximal distance antenna to tag [cm]	14	9.8	9	8	7	6	3.5	2.8
Middle distance antenna to tag [cm]	5	5.1	5.3	5.5	5.8	4	-	-
Minimal distance antenna to tag [cm]	-	4.7	4.5	4.3	4.2	-	-	-

Table 8: Relation between RSSI and distance antenna to tag (data)

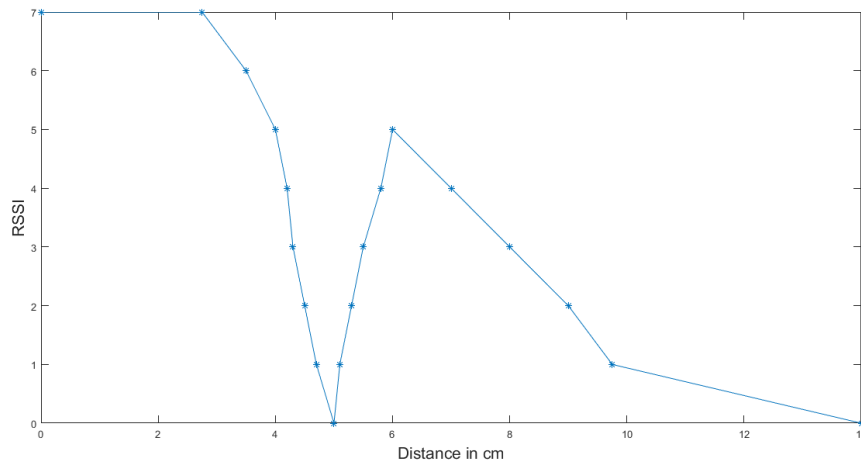

Figure 28: Relation between RSSI and distance antenna to tag

Figure 28 demonstrates that there exists a blind spot at a distance of 5 cm where the RSSI drops to 0. The consequence is that it is not trivial to build up a relation from the RSSI back to the correct distance.

6.3 Simulation with emulated data

The idea of the final implementation is to estimate the initial position and orientation of the robot. A first version of an algorithm to solve this problem is created in matlab. The first part of these algorithm is the emulator which simulates the 360° turn and records the tag information. The second part is the solver which is also explained in depth in the section 7. After observing an inconsistent behaviour of the RSSI the simulation as well as the solver were updated.

6.4 Results

The application of the emulated data on the solver indicates the following results:

	Avg. accuracy position (x-, & y-direction) [mm]	Avg. Accuracy orientation [°]
Data mentioned in paper	2	<1
Own recorded data (blind spot)	10	20

Table 9: Results Simulation

As can be seen from table. 9, there is a sufficient good match between the estimated position and orientation of the robot for the consistent RSSI data. On the other hand the inconsistent RSSI data results in significant differences in the estimation of the position and orientation of the robot.

The reason for this is the higher complexity of the algorithm to first estimate the correct distances related to RSSI values and then start to estimate the position based on those distances.

A small error in the estimation of the position of the antenna at the first measurement point leads also to a big error in the computed orientation of the robot.

7 Implementation

7.1 Communication

The already existing software is overwritten on the built-in micro-controller of the WeMos Wifi Module which was developed to have a continuous listening to all the data sent from the RFID reader even in case of no tags within the range. The complete and erroneous RFID data readings are as seen in the fig.29.

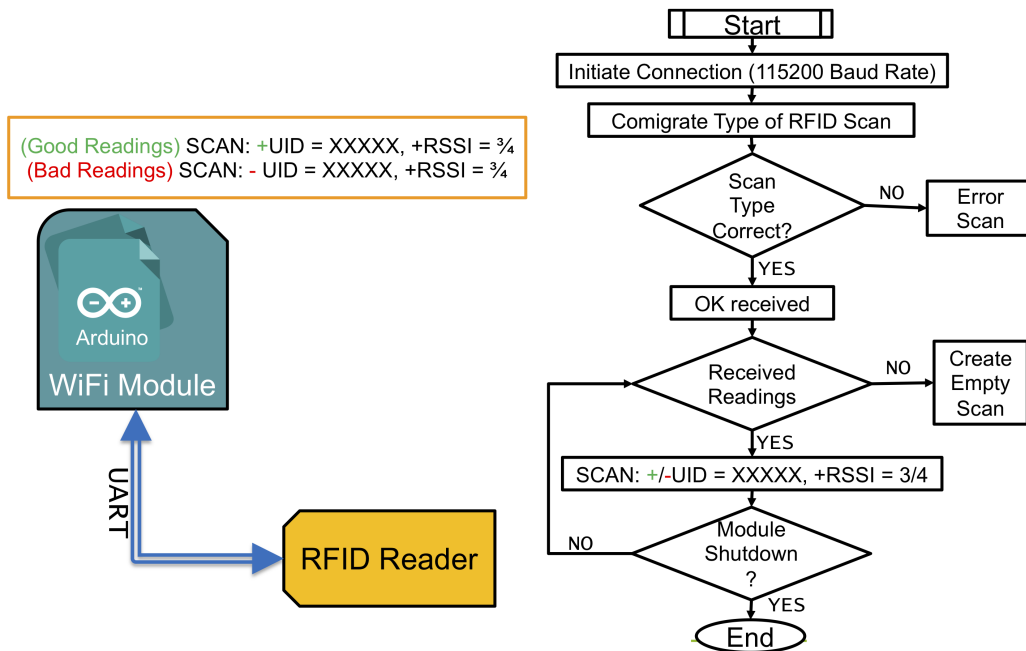

Figure 29: RFID-WeMos Module Communication

A TCP-IP communication is established within the network on the WeMos WiFi Module that start publishing the data which has been received from the reader. This communication is killed if and only if in the case of robot shutdown as shown in fig.30.

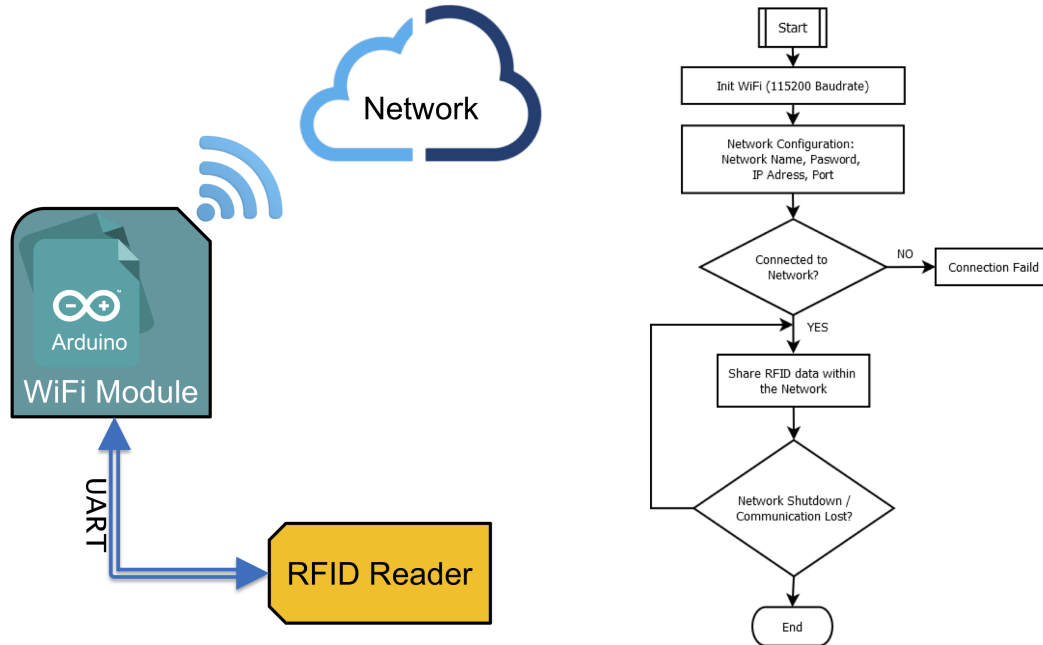

Figure 30: WeMos Module Network Communication

While on the other side of computer GUI (Graphical User Interface), the similar communication is being established (which should be on the same network) and should grasp all the data that has been published by the WeMos WiFi module even if there exists no feedback. This communication can be terminated on the GUI if required as shown in the fig.31.

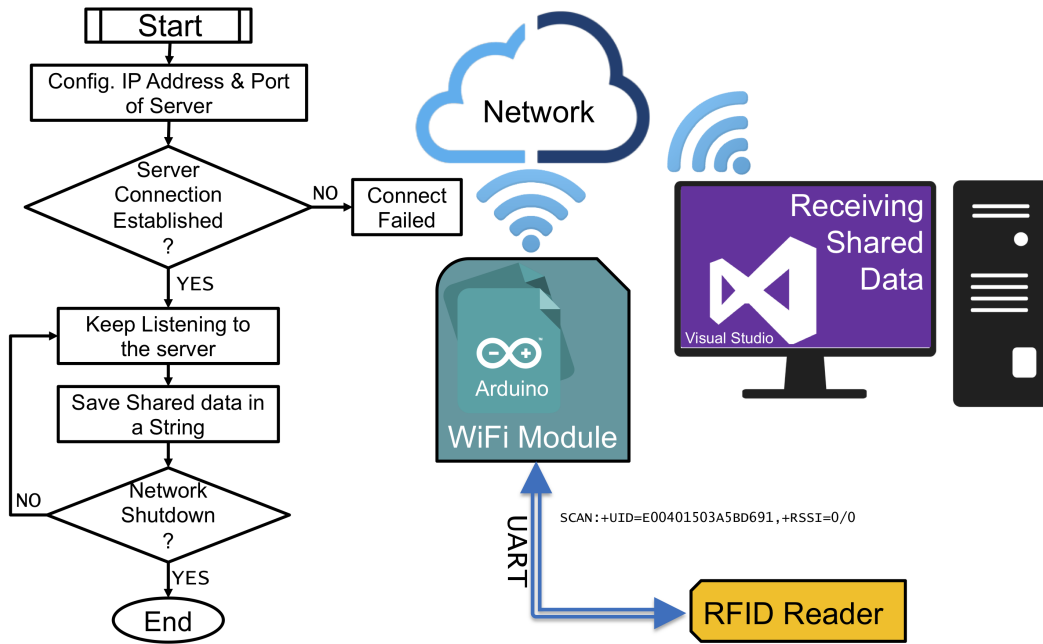

Figure 31: Computer Network Communication

7.2 Initialization procedure

In the start-up phase, before running the pipeless plant with its AGVs, the correct position and orientation of each and every vehicle are not known. Even though the controller is able to compute the position of the AGVs antenna in each point of time ($t=0$ included), several AGV positions in the plants operation space can be described by one single antenna position. In fig. 32 four possible AGV positions with one common antenna position are pointed out.

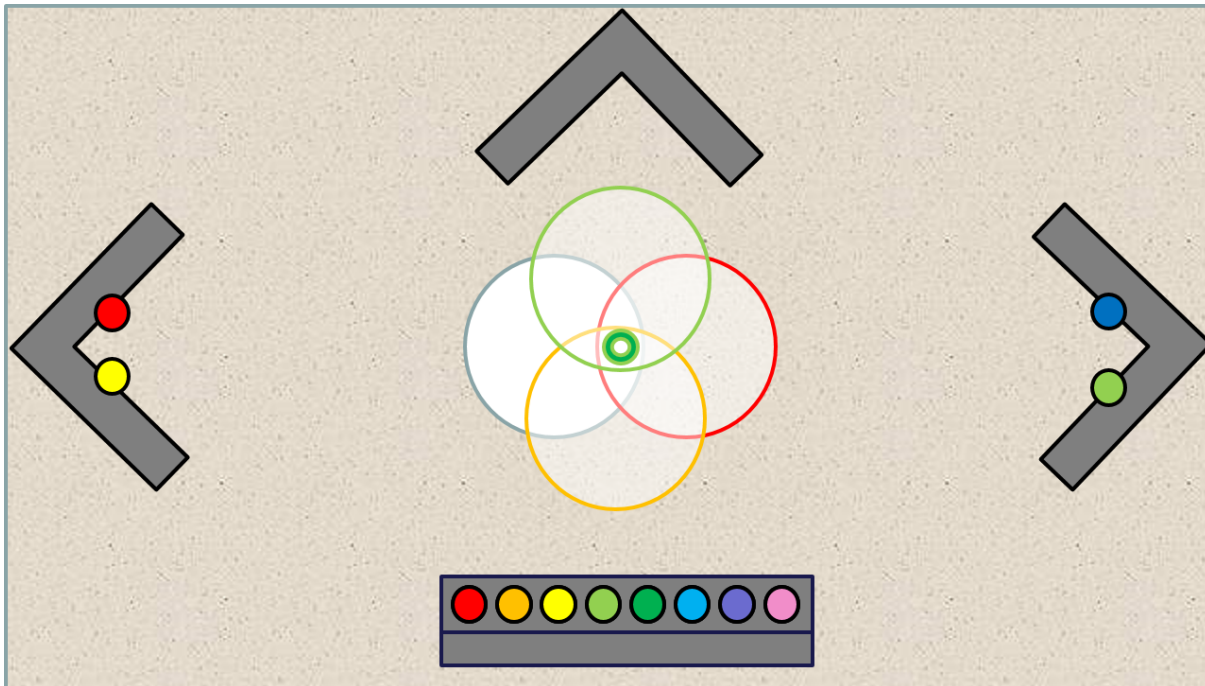

Figure 32: Different possible positions for one antenna position

Since the position information is crucial for the plant, a procedure was set up to determine the starting positions of each and every AGV. According to the fact that the position and orientation of a single AGV is unknown at the beginning, some potential hazards were taken into account. For instance, the plant contains several obstacles like the mixing stations, vessel storage, charging stations, plant edges and even other vehicles as represented in fig. 33.

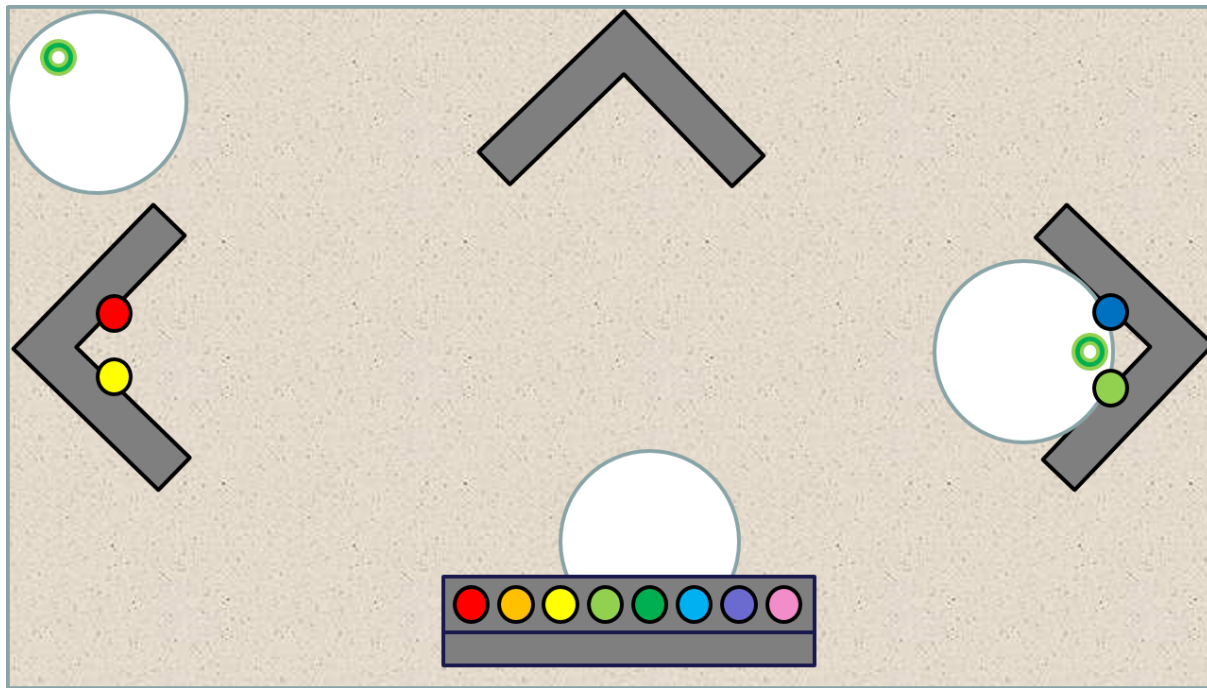

Figure 33: Possible hazards/obstacles

With respect to these potential hazards, collisions during the initialization procedure have to be avoided. This is realized by taking advantage out of the AGVs ability to turn around its z axis without a change of the AGVs center point in x and y direction. This ability of the AGV leads the way that each and every robot performs an initialization turn of 360° . During this turn the reader takes measurements every 45° to estimate the specific positions and orientations of the AGVs. Furthermore, the fact, that the position of the center point does not change during a turn around its z axis, dominates the decision process of the antenna position under the robot. During the 360° turn, the intervals of taking measurements need to be known by the controller. The determination of these measurement points can be computed in two different ways. On the one hand, the controller uses the encoders of the AGV-wheels to estimate the performed rotation. On the other hand, the time of a complete turn is measured and used as a parameter in the procedure. In terms of simplicity the algorithm includes the second option during the initialization procedure. Fig. 34 illustrates a sequential flow chart which describes the movement and data processing during the initialization procedure. The part of the code which is explained and visualized by Fig. 34 is found in section 11.4

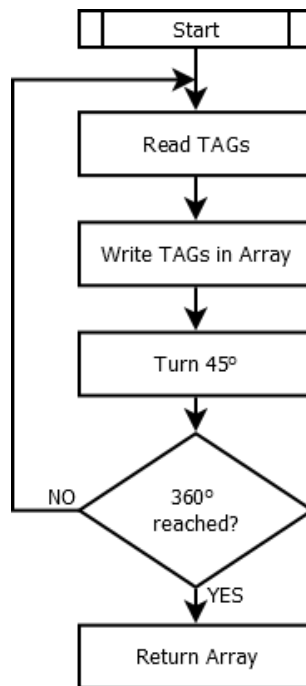

Figure 34: Flow Chart: Initial procedure 360° turn

The initialization procedure for AGV No. 1 is created and a button in the test environment starts the respective part of the algorithm. In the first place the user types an integer number in the field called sleeptime. This integer number is interpreted as milliseconds and describes the time of rotation. Even though a time for a complete turn of 45° has been found at around 1125ms, it has to be said that this time strongly depends on the battery charge of the AGV. After the desired turning time is given to the GUI, the initialization button, located over the input box in fig. 35, starts the initialization procedure.

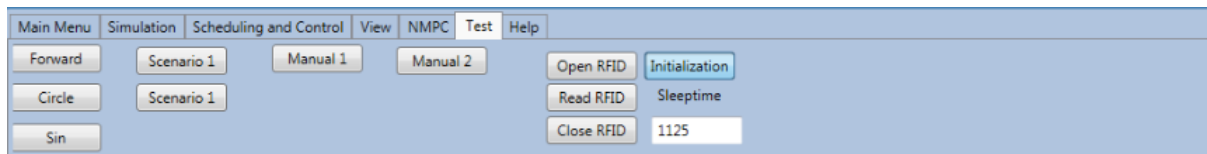

Figure 35: Test environment in GUI

In the second step, after the procedure was started, the RFID-Reader reads all the available IDs and their respective RSSI in its current reading range. The reading is performed in

the Automatic Scan mode of the RFID reader[13]. With the included timestamp for every measurement a delay of minimum 30ms between each tag information was detected. With respect to this delay, the antenna stops a specific period of time at each measuring point to deliver correct data of all the reachable tags. Experiences have shown that a measuring time between one and two seconds delivers the best results. During this time, the controller receives new measurement information every 100 ms. In order to save the single tag information of each and every measuring point, an initially empty array with 14 columns and 8 rows was created. The number of rows is derived by the fact that the system takes measurements every 45°.

$$Rows = 360^\circ / 45^\circ = 8 \quad (12)$$

$$(13)$$

The first seven columns in the array contain the received tag IDs and the last seven entries describe the respective RSSI.

The number of columns is derived by the fact that at each and every measurement point in the used test environment, information of maximal seven tags can be read.

$$Columns = \text{max.no.of tags} * 2 = 7 * 2 = 14 \quad (14)$$

$$(15)$$

Once the received data is saved in its corresponding row, the AGV turns around 45° and places the antenna at the next measurement point. An AGV turn is realized by setting the velocity of the right and left wheel in different directions. During the turning sections the velocity is set to 100 mm/s or rather -100 mm/s. This procedure of reading information, writing information in the initialization array and turning 45° to the next measuring point is repeating itself until a 360° turn is performed. After a successful initialization turn, the corresponding array of measurement information can look like the example in table 10. The code which realizes the filling of the array can be seen in section 11.5

4	1	5	2	3			0	0	1	7	0		
5	3						2	3					
3	5						2	2					
9	8	6	5				1	1	1	2			
9	7	8	6	4	5		2	0	6	0	0	2	
4	7	5	8				0	2	3	3			
5	4	7	8	1			2	5	0	0	0		
2	4	1	5				0	2	2	0			

Table 10: Filled initialization array after 360° turn

7.2.1 Recording and filtering data

To read the ID and RSSI of all the tag laying in the reading range, the RFID-reader performs in its Automatic mode and its Anticollision is switched on. In this mode the plans computer receives packages of strings with a length of 36 characters. Even though these 36 character strings contain all the information of the tag which is needed the algorithm separates the useful parts and delivers them to the localization algorithm for further computations.

With exception of the information each string contains, the structure itself is always the same. In the first five characters the substring “SCAN:” is detected and deleted for the further process. The sixth slot of the string is the first important character. It contains either a “+” or a “-”. With the help of this sixth slot it is distinguished whether the current reading is complete or not. In order to guarantee the correctness of the received information the measurements are filtered by the “+” and the measurements in which a “-” is included are ignored in the further processes. After the indicator for complete and incomplete readings an introduction to the ID is indicated by “UID= ” and cut out of the string. The next 16 characters define the unique identification of the specific tag. As a last useless string, which has to be cut out, with the structure “.RSSI=” is found directly after the ID. As a result the 16 character hexadecimal ID and its respective RSSI are separated from the received string. Since the ordered tag IDs differ each other just in the last three numbers, these numbers are transformed in a decimal number before UID and RSSI are used for further computations. The code which realizes the recording and filtering of the data can be seen in section 11.2

String Transformation	
Complete	Incomplete
SCAN:+UID=E00401503A5BD691,+RSSI=0/0	SCAN:-UID=E00401503A5BDAE4
UID=E00401503A5BD691,+RSSI=0/0	
E00401503A5BD691 0/0	
1681 0	

Table 11: String preparation

7.2.2 Analysing data

In the next step, the algorithm analyses the previously described filled array. To estimate the position and orientation of the AGV, the array has to include two valid sets of each two valid measuring points. During this analyzation, following restrictions validate the single measurement point-sets:

- At the two valid measurement point each contains at least three tags.
- The other measurement point in one set needs to have a distance of 180° to the first.

In terms of getting the adequate sets of measurement points the array is analyzed row by row. The stepwise workflow is visualized in fig. 36.

The code in which the analyzation is realized can be seen in section 11.6

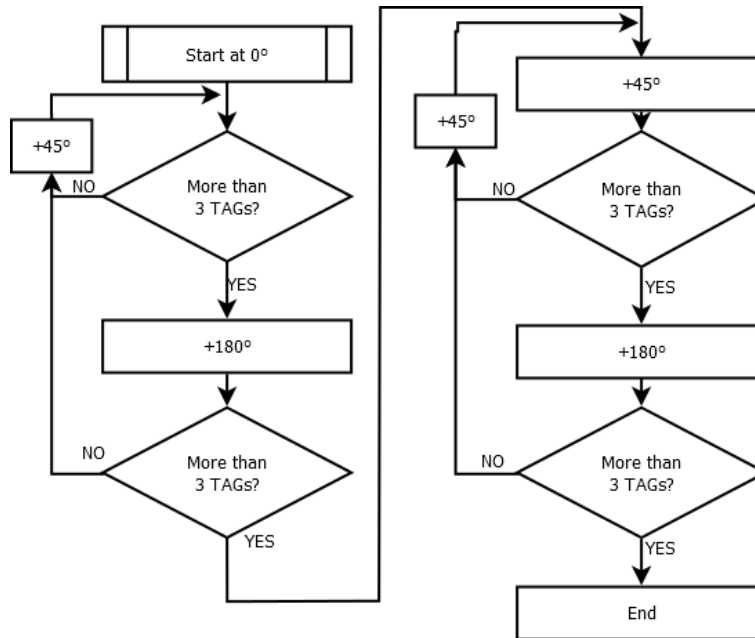

Figure 36: Flow Chart: Analyzing initialization measurement points

Initially the algorithm checks the first row which represents the measurement at the point 0° in terms of the number of readable tags. If this specific number is higher or equal three the transition is acknowledged as true and the same query will be performed at the measurement point with a distance of 180° to the former measurement point. If this next measurement point can be described as valid, the first valid set of two measurement points is found. If, on the other hand, the number of readable tag are less than three, which means that the triangulation algorithm cannot be performed, the current measurement point is ignored and the next measurement point is evaluated. Each of these sets of two measurement points is saved as a 1×2 array called solution 1 and solution 2 is used for the estimation of the position of the measurement points which is explained in the section 7.2.4 estimation of initial position and orientation.

7.2.3 Selection of correct distance related to RSSI

In the first step, the multiple occurring data points (see table 8) are divided into three groups, (max, middle and min) where max means the maximal possible distance related to one RSSI and so on.

The measurements have shown that it is not trivial to define the correct distance related to most

of the RSSI. The involved algorithm selects the correct distance out of the multiple possible solutions and is shown in fig. 37:

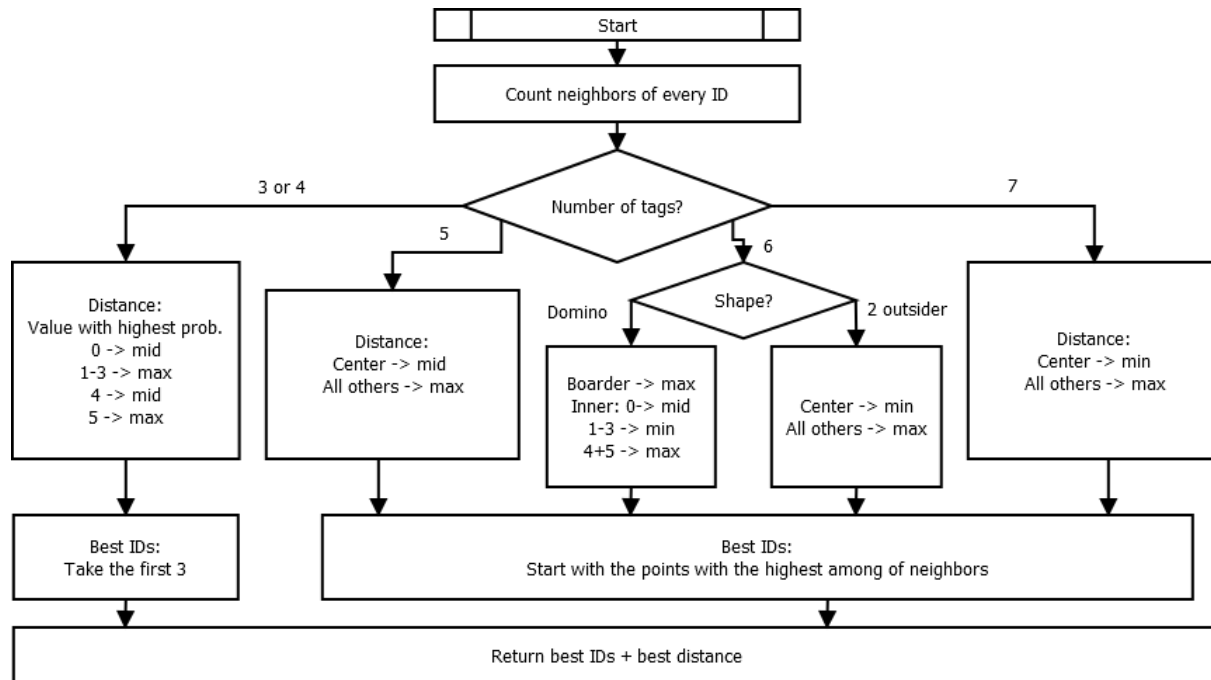

Figure 37: Flow Chart: Selection of correct distance and most proper IDs

To distinguish between the multiple possible solution for one RSSI, the algorithm defines the shape of the pattern of tags based on the number of tags at each measurement and the number of the neighbours each tag has. At each measurement point in this scenario several numbers (4-7) of detected tags are possible. The different shapes can be found in the table 12.

Number of detected tags	4	5	6 (Domino)	6 (2 alone)	7
Unique shapes					

Table 12: Possible shapes of pattern

Going back to the flow chart fig.37 the first step is to count the number of neighbours each tag has. With this information, the position of the tag in the pattern can be detected. For example, a tag with 3 neighbours in a pattern of 5 tags, is the center of this pattern.

After the number of tags at each measurement point and the position of each tag are defined, the selection of the correct distance will be performed based on the highest probability. To know the highest probabilities an analysis of measurements with emulated data has been done.

As an example 4 detected tags are leading to the fact that the position of the antenna should be very close to the center of this square. If in this case a RSSI of 4 is detected, the middle value (5.8 cm) will be taken.

Afterwards the most suitable three IDs will be selected, in case where more than three are detected. The algorithm takes at first the ID with the highest amount of neighbours, because these tags are close to the position of the antenna and have probably a value of 6 or 7 and are uniquely defined. In the case where several tags with the same number of neighbours, the first ID (number increasing) will be taken.

The return of the function is an array (2x3) with the indices of the chosen IDs and the correct distance. The correct distance will be indicated by the number 0,1 and 2. 0 means the maximal, 1 the middle and 2 the minimum possible value related to one RSSI. For example

$$\begin{bmatrix} 3 & 2 & 4 \\ 2 & 0 & 0 \end{bmatrix}$$

leads to the choice of the maximal value of the RSSI of the fourth detected ID and the minimum value of the RSSI of the third and the fifth ID in the recorded array at this measurement point.

7.2.4 Estimation of initial position and orientation

As mentioned in chapter 7.2, the main idea to estimate the initial position is to find the intersection point, which lies in the middle of the measurement points.

To compute this position, the algorithm uses trilateration at every suitable measurement point to estimate its position. For trilateration are three defined positions plus three radii necessary, which are available after the selection of the correct distance and proper IDs.

As follows from the fig.38 shown above, the intersection point is found by computing two linear functions which go through two corresponding points (blue lines). The center of the robot is then the intersection of those two linear functions and can be computed by the following equations:

$$x = \frac{(x_1y_2 - y_1x_2)(x_3 - x_4) - (x_1 - x_2)(x_3y_4 - y_3x_4)}{(x_1 - x_2)(y_3 - y_4) - (y_1 - y_2)(x_3 - x_4)} \quad (16)$$

$$y = \frac{(x_1y_2 - y_1x_2)(y_3 - y_4) - (y_1 - y_2)(x_3y_4 - y_3x_4)}{(x_1 - x_2)(y_3 - y_4) - (y_1 - y_2)(x_3 - x_4)} \quad (17)$$

Theoretically all eight measuring points are suitable points (at least four IDs found). But for the case that the real measurements differ from the theory, the algorithm just needs four

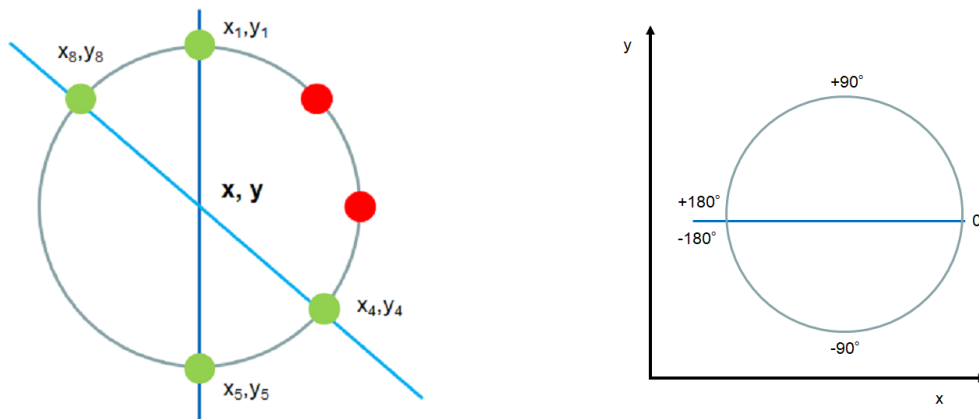

Figure 38: Computing the center of the robot Figure 39: Orientation of robot in absolute angle

suitable points.

After the initial position as well as the positions of 4 measurement points are known, the algorithm computes the orientation based on those information. The relative angle between the center and the first measurement point will be computed with the $\arctan2$ function and leads to an orientation $-180^\circ < \Theta \leq 180^\circ$ as shown in fig.39.

To compute the absolute angle, the angle of the measurement point has to be subtracted and 180° has to be added. This is caused by the fact that the antenna is placed on the back of the robot and the absolute orientation should be the direction of the front. After this computation, the initial position and orientation of the robot are known.

7.3 Test setup

In order to verify the validity of the initialization procedure, experiments with the components mentioned in chapter 5 were carried out. The beginning of these experiments were the reconstruction of one of the AGVs with this hardware setup. After all components were added to the AGV the power supply was realized via a powerbank and the USB connection of then wifi modul. The plan is to replace this in the future with a direct connection to the battery of the AGV. Fig.40 gives an overview of the test setup and shows that also for the prototype, the reader and the WiFi modul was just stuck with Sellotape on the upper layer of the AGV.

The test platform was a field of 9 tags which were stuck on a piece of carton. The IDs and its positions are shown in table 13.

The reason for the small setup was the fact that until the end of the project only 10 tags were available. One of the following steps should be to extend the platform with more tags.

The initialization procedure was started via the GUI. A time value was added in the GUI to perform the 45° turns. This number was around 1125 ms and is highly correlated to the battery

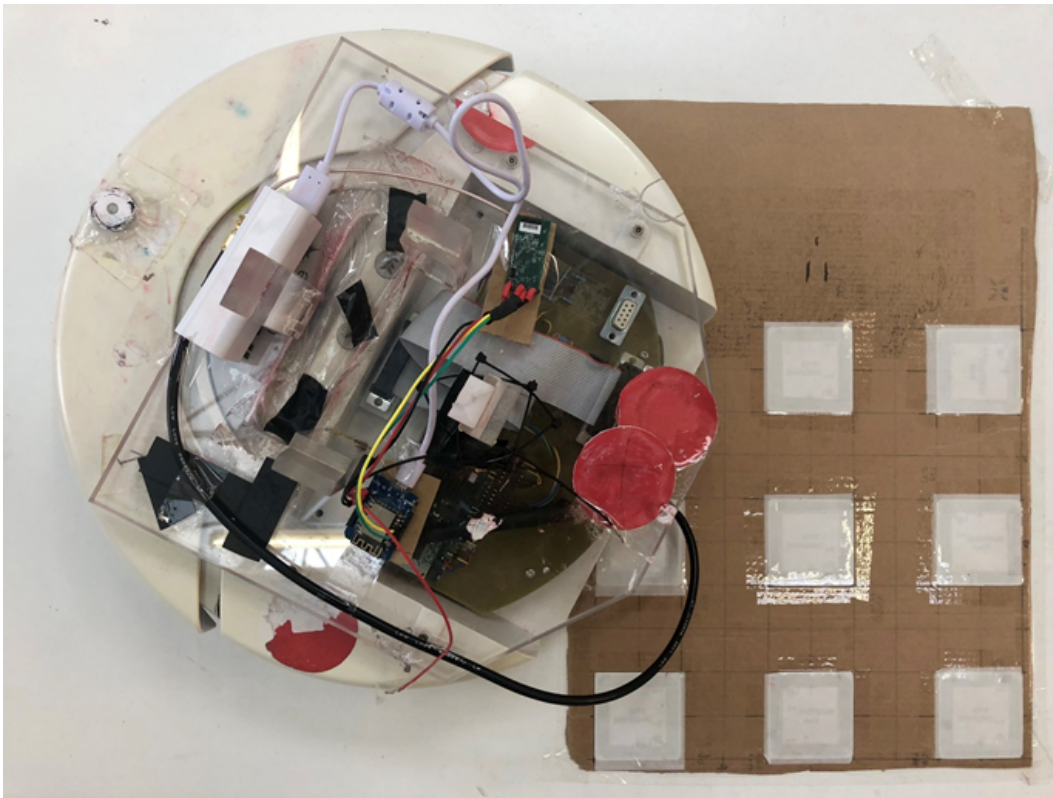

Figure 40: testing setup for initialization procedure

X-dir. [mm]	0	100	200	0	100	200	0	100	200
Y-dir. [mm]	0	0	0	100	100	100	200	200	200
ID tag [hex]	AE4	689	47A	586	785	ADC	BF4	691	78D
ID tag [dec]	2788	1673	1146	1414	1925	2780	3060	1681	1933

Table 13: Positions of the IDs in the test setup

status of the AGV.

7.4 Results

A couple of tests on the test setup (previous section) were performed to compare the good results created with the simulated data with real measurements. The result of the position estimation was directly plotted in the console. The initial position was 200 mm in x- and y-direction and a varying orientation (0° , 90° , 180° and -90°). Fig.41 and fig.42 illustrate the actual measurement results and the desired position in x- and y-direction.

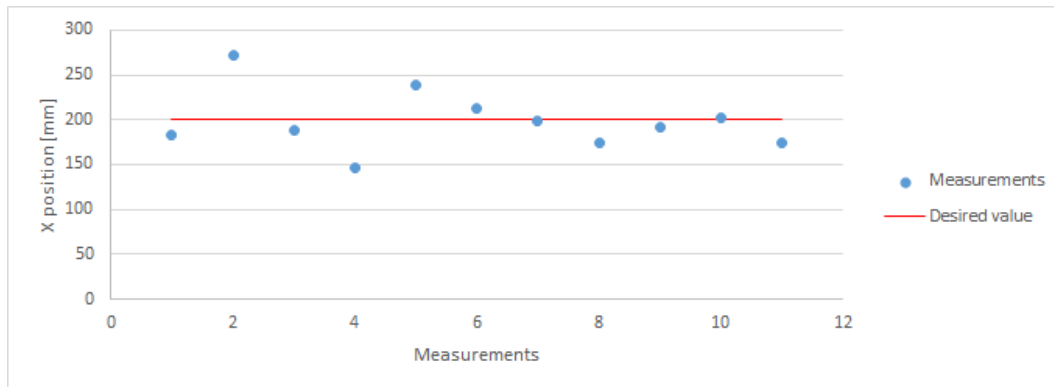

Figure 41: Estimated position in x-direction

The average of the absolute error of the position in x-direction was 24.5 mm. The minimum and maximum error were 2 mm and 72 mm.

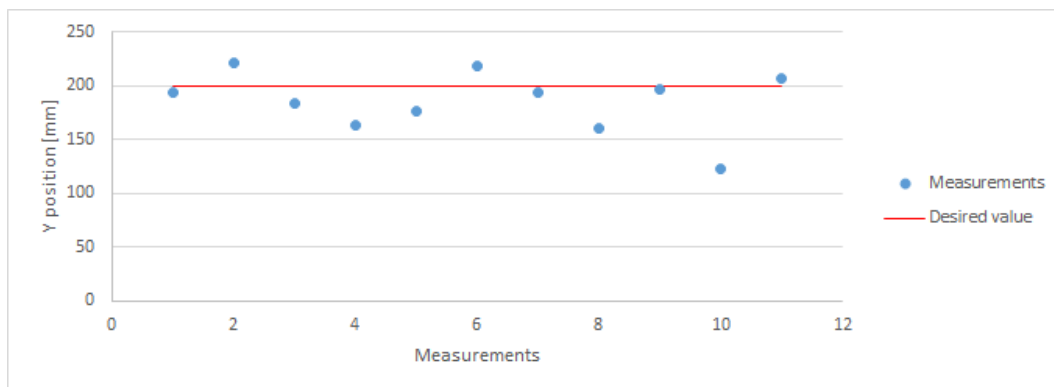

Figure 42: Estimated position in y-direction

The average of the absolute error of the estimation of the position in y-direction is with 23.3 mm, a minimum error of 3 mm and an maximum error of 77 mm very similar to the results

from the estimation of the x-direction. The computation of the overall error of the position has an average derivation of 37.5 mm and a minimum and maximum error of 6.3 mm and 77 mm.

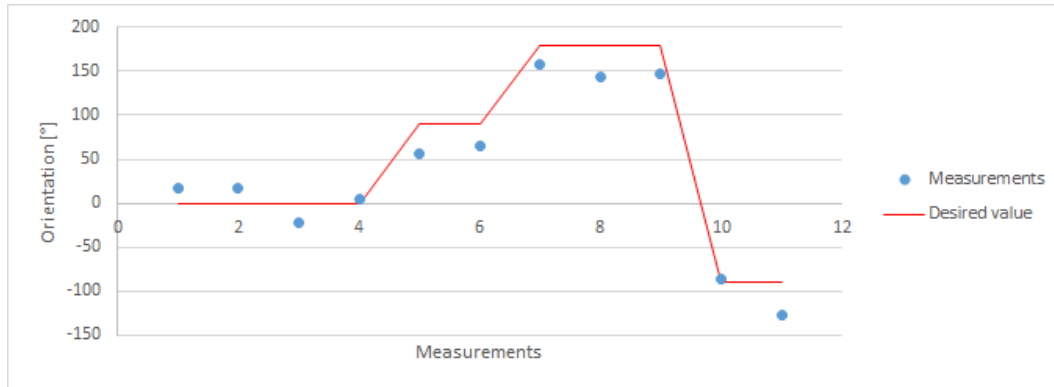

Figure 43: Estimated orientation

For the estimation of the orientation, the average of the absolute error was 23° with a minimum and a maximum value of 3.9° and 37.5° . The measurements also shows that an estimation of the position with a big error not necessarily leads to a big error in the estimation of the orientation (see measurement 4 in fig.41, 42 and 43).

An extension of the results could also be an analyse of the estimated positions of the antenna at the measurement points. Those points were also plotted in the console.

8 Conclusion

The developed localization solution was for the pipeless plant, a prototype of a chemical production plant which has a size of 3 by 4 m. In this plant the vessel will be transported by AGVs from one station to another. In the actual setup only a camera, which is installed above the plant, was used to detect the AGVs and estimate their positions. The problem with this technology is the bad detection of the LED pattern from the AGVs during bright light conditions and also the space limitation. Another big disadvantage is the big computation effort which makes the system also very slow. The main task of this project was to find an alternative tracking solution. During the project group phase different localization technologies were evaluated. With respect to the outcoming researches about triangulation, map-based-localization, pattern recognition and localization via radio frequency identification the last RFID based localization of the AGV with passive tags as landmarks turned out to be the most promising among those four. With information of a similar project realized by the FH Dortmund a model to evaluate sample data and a localization algorithm was created in Matlab. This results of the simulation were promising and therefore used during the decision making process about the actual hardware setup. With an demonstration board with the size of 30 cm x 30 cm the initialization procedure algorithm was implemented in which the AGV performs a 360° turn and estimates its position and its orientation based on measurements during this movement. With respect to this solutions it can be said that it is possible to assemble a reader on an AGV and detect passive tags with its antenna in a range of 14 cm. It also has been found out that an inconsistent relation between the RSSI of the detected tags and the distance based on the RSSI is not generally trivial and was only solved in a rather simple and unreliable way during the project. Based on the results computed by the initialization procedure, it can be concluded that it is possible to estimate the position of the AGV with an average accuracy of around 2.5 cm and an estimation error of the orientation of around 23°. Compared to the former localization set up this solutions, especially with respect to the orientation error, are not perfectly satisfying and just minimal requirements are fulfilled. The received data from the RFID reader have furthermore clearly shown that the anti-collision algorithm used by the reader leads to an unknown amount of time until each and every tag in the detection area is identified. Summed up a model based demonstrator was realized which on the one hand does not improve the accuracy of the localization of the plant under good light conditions especially with respect to the orientation but on the other hand a promising technology for indoor localization with light independency, respectively cheap costs and highly scalability was found.

9 Future work

After a proof-of-concept for an RFID based localization system has been built and a first demonstration set-up has been created, the disadvantages and limitations of the prototype were evaluated. According to these results, several points of improvement and extension were found and categorized into hardware and a software section.

9.1 Hardware

- The AGVs are fed by an included 12V battery which provides the power for all included electrical devices. This 12V power supply is available on board and is suggested to be used. Currently the WiFi-Module and the RFID-Reader are fed by an external powerbank since a 5V power supply is needed. In terms of one centralized power supply, a 12 V to 5 V converter can be installed and connected to the reader and WiFi module.
- As a first setup, a demonstration area of 3 x 3 tags was build. In this rather small area, the initializaion procedure was developed, but a real time localization while a path is followed by an AGV was not possible since the 30cm x 30cm was simply to small. For futrue research in terms of localisation on a specified path, additional tags can be included to the area of operation. Since the RFID concept is highly scalable, the only change that needs to be made in the algorithm is the insertion of the additional tag into the lookup table.
- Currently the robot no. 1 is the only AGV which is equipped with the RFID technology. To run the plant with multible AGVs, the remaining robots needs to be upgraded.

9.2 Software

- During the initialising procedure a 360° turn is performed. The desired turn around 45° is realized by a driving time of 1125 ms. But it needs to be said that this movement is highly dependend on disturbances like changing battery charge and plant underground. For the future developers it is suggested to use the encoders of the robot wheels as a determination of the orientation instead of the parameter time.
- As an alternative localization technology was found several code lines in the current code can be deleted since the camera and image processing is simply not used anymore. With a clean code an improvement of processing time will be achieved.
- As a last point it can be said that even though a localization with RFID is now possible the results are not 100 percent realiable and the accuracy especially with respect to the orientation is not satisfying so far. As an improvement the triangulation algorithm has to be optimized and or a second RFID-antenna has to be added under the AGV to reduce measurment errors.

10 References

References

- [1] Yihuan Zhang Liang Wang and Jun Wang. Map-based localization method for autonomous vehicles using 3d-lidar. *IFAC (International Federation of Automatic Control) Hosting by Elsevier*, 50, 2017.
- [2] Dr.-Ing. habil. Dipl.-Ing. Dipl.-Ing. Joerg Wollnack. Prinzip der dreidimensional messenden videometrischen messsysteme.
- [3] Jeremie Houssineau, Daniel Clark, Spela Ivekovic, Chee Sing Lee and Jose Franco. A unified approach for multi-object triangulation, tracking and camera calibration.
- [4] Matteo Munaro, Edmond Wai Yan So, Stefano Tonello, and Emanuele Menegatti. Efficient completeness inspection using real-time 3d color reconstruction with a dual-laser triangulation system. 48:201–225, 09 2015.
- [5] Richard I. Hartley, Peter Sturm. Triangulation.
- [6] F. Dias, H. Schafer, L. Natal, and C. Cardeira. Mobile robot localisation for indoor environments based on ceiling pattern recognition. In *2015 IEEE International Conference on Autonomous Robot Systems and Competitions*, pages 65–70, 2015.
- [7] Jun Liu Baoxian Zhang and Haoyao Chen. Amcl based map fusion for multi-robot slam with heterogenous. *IEEE International Conference on Information and Automation (ICIA)*, 6, 2013.
- [8] ROS. Amcl, 2018.
- [9] Yuntian Brian Bai, Suqin Wu, Hongren Wu, and Kefei Zhang. Overview of rfid-based indoor positioning technology, 2012.
- [10] Hanifa SHAH Kamran AHSAN and Paul KINGSTON. Rfid applications: An introductory and exploratory study. *International Journal of Computer Science Issues*, 7(3), 2010.
- [11] Vinita Sharma Ms.Neha Kamda and Sudhanshu Nayak. A survey paper on rfid technology, its applications and classification of security/privacy attacks and solutions. *IRACST - International Journal of Computer Science and Information Technology & Security*, 6(4), 2016.
- [12] Pablo Cotera, Miguel Velazquez, David Cruz, Luis Medina, and Manuel Bandala. Indoor robot positioning using an enhanced trilateration algorithm. *International Journal of Advanced Robotic Systems*, 13(3):110, 2016.
- [13] KTS Systeme. Rfid plug module rfidm1356, 2017.

- [14] WEMOS. Wemos d1 mini, 2018.
- [15] Christof Rohrig, Daniel Hess, and Frank Kunemund. Rfid-based localization of mobile robots rfid-based localization of mobile robots using the received signal strength indicator of detected tags.

11 Appendixes

11.1 Appendix A: Emulator RFID data (Matlab)

```

1 %% -----
2 % Description:  Emulator, which creates txt file like the reader
3 %              RSSI related to the real measurements
4 %              For the Initialization procedure, turn around 360°
5 % Date:        12.06.2018
6 % Created by:  Stephan Vette
7 %% -----
8 %% RFID signal emulator
9 clear all
10 clc
11 close all
12 % Initializing
13 l1 = 100; % length of the plant, x [cm]
14 l2 = 11; % width of the plant, y [cm]
15 d1 = 10; % distance between tags [cm]
16 d2 = 0; % distance last tag <-> boarder [cm]
17 r1 = 14; % radius of the reading range of every tag
18 r2 = [r1, 9.75, 9.0, 8.0, 7.0, 6.0, 5.8, 5.5, 5.3, 5.1, 5.0, 4.7, 4.5, 4.3, 4.2, 4.0,
19       3.5, 2.75, 0]; % distances at certain RSSI
20 r4 = [0, 1, 2, 3, 4, 5, 4, 3, 2, 1, 0, 1, 2, 3, 4, 5, 6, 7, 7]; % array with the
21       different RSSI values
22
23
24 r3 = 33/2; % radius of the robot
25 d3 = 10; % distance between origin robot and origin antenna [cm]
26
27 angle1 = 45; % angle between the measurement points in the init procedure
28
29 gammal = deg2rad(22.5); % Start orientation of robot [rad]
30 robStart = [22.5, 51.5]; % Start position of robot in x, y [cm]
31
32 robSpeed = 0.1; % Speed robot [m/s]
33 cycleT = 100; % Cycletime in [ms]
34
35 mode = 1; % mode=1: tracking all available tags, which are nonzero
36 % mode=2: tracking only changes in the RSSI signals
37 mode_hex = 0; % activate or deactivate hex ID
38
39 % For the name of the txt file
40 meausurementNumber = num2str(11); % Number of measurement
41 % Two possibilities for the content of the txt file
42 % 1. Without filtering. Exactly like the reader creates data
43 % text0 = '<\r>';
44 % text1 = 'OK';
45 % text2 = 'SCAN:+UID=';
46 % text3 = '+RSSI=';
47
48 % 2. Filtered data. Without unusable information.
49 text0 = ' ';
50 text1 = ' ';
51 text2 = ' ';
52 text3 = ' ';
53 %% Error check
54 if mod(l1/d1,1)~=0
55     error('Length of platform not dividable by distance between tags');
56 elseif mod(l2/d1,1)~=0

```

```

54     error('Length of platform not dividable by distance between tags');
55 end
56
57 %% Computing position of antenna
58 numTagsX = (l1-2*d2)/d1 +1;
59 numTagsY = (l2-2*d2)/d1 +1;
60 numTags = numTagsX * numTagsY;
61 antPos = robStart + d3 * [cos(gammal), sin(gammal)];
62
63 %% Display the setup, write important information into a seperate txt file
64 d1_str = num2str(d1);
65 l1_str = num2str(l1);
66 l2_str = num2str(l2);
67 numTags_str = num2str(numTags);
68
69 msg0 = ['Your plane is ',l1_str,'cm x ',l2_str,'cm.'];
70 msg1 = ['You chose a distance of ',d1_str,'cm and need ', numTags_str,' Tags!'];
71 disp(msg0);
72 disp(msg1);
73 nameTxt = ['NumTags',measumeenteNumber,'.txt'];
74 fileNumTags = fopen(nameTxt,'w');
75 fprintf(fileNumTags,'%6d\n',numTags); % Write the number of tags in file
76 fprintf(fileNumTags,'%6d\n',l1); % Write the size of the plant in file
77 fprintf(fileNumTags,'%6.4f\n',gammal); % Write the starting angle
78 fprintf(fileNumTags,'%6d\n',robStart(1)); % Write the starting pos
79 fprintf(fileNumTags,'%6d\n',robStart(2)); % Write the starting pos
80 fclose(fileNumTags);
81
82
83 %% Drawing environment
84 figure(1)
85 x1 = [0 l1 l1 0 0];
86 y1 = [0 0 l2 l2 0];
87 plot(x1, y1, 'LineWidth',2)
88 xlim([-5 (l1+5)]);
89 ylim([-5 (l2+5)]);
90 hold on
91
92 % Position of the tags
93 ID = 1:numTags;
94 [Tagx,Tagy] = meshgrid(d2:d1:l1-d2,d2:d1:l2-d2);
95 plot(Tagx,Tagy,'r*')
96 % Circles
97 radiipl = ones(numTagsX,1)*r1;
98 for k=1:numTagsX
99     tempx = Tagx(1:end,k);
100    tempy = Tagy(1:end,k);
101    temppos = horzcat(tempx,tempy);
102    viscircles(temppos,radiipl,'Color','k','LineStyle',':', 'LineWidth',0.25);
103 end
104 robX = robStart(1);
105 robY = robStart(2);
106 plot(robX,robY,'bo','LineWidth',3);
107 plot(robX,robY,'r:');
108 viscircles([robX,robY],r3,'Color','k','LineWidth',0.25);
109 plot(antPos(1),antPos(2),'bs');
110 xlabel('Length platform in cm')
111 ylabel('Width platform in cm')
112 title({'Position and reading range of tags';'Start-, endpoint and path of the robot'});

```

```

113 hold off
114 pause(1)
115
116 %% Animation and logging
117 xUpdateAnt = antPos(1);
118 yUpdateAnt = antPos(2);
119 deltaR = deg2rad(angle1);           % A new measurement after every XX°
120 % Txt file name
121 name = [ 'Meas.StartingProc.like_reader_real_data',measurmentNumber, '.txt' ];
122 fileID = fopen(name, 'w');
123
124 % Data stored in variables
125 dataRSSI = zeros(8,numTags);
126 streamDataRSSI = zeros(1,numTags);
127 streamDataRSSIold = zeros(1,numTags);
128 timeStep = 1; % current measurement step
129
130 % antPos = robStart + d3 * [cos(gammal), sin(gammal)];
131 figure(2)
132 for l=0:360/angle1
133     deltaR_temp = deltaR * l;
134     xUpdateAnt = robStart(1) + d3 * cos(gammal + deltaR_temp);
135     yUpdateAnt = robStart(2) + d3 * sin(gammal + deltaR_temp);
136     plot(x1, y1, 'LineWidth',2)
137     hold on
138     xlim([-5 (l1+5)]);
139     ylim([-5 (l2+5)]);
140     [Tagx, Tagy] = meshgrid(d2:d1:l1-d2, d2:d1:l2-d2);
141     plot(Tagx, Tagy, 'r*');
142     plot(robX, robY, 'bO', 'LineWidth',1);
143     plot(robX, robY, 'r:');
144     plot(xUpdateAnt, yUpdateAnt, 'bs');
145     xlim([-5 (l1+5)]);
146     ylim([-5 (l2+5)]);
147     viscircles([robX, robY], r3, 'Color', 'b', 'LineWidth', 0.5);
148     for k=1:numTagsX
149         tempx = Tagx(1:end, k);
150         tempy = Tagy(1:end, k);
151         temppos = horzcat(tempx, tempy);
152         viscircles(temppos, radiipl, 'Color', 'k', 'LineStyle', ':', 'LineWidth', 0.25);
153     end
154 hold off
155
156 % Creating measurements
157 antPosnew=[xUpdateAnt, yUpdateAnt];
158 for m = 1:numTags           % m = current number of tag
159     m_str = num2str(m);
160     tempTag=[Tagx(m), Tagy(m)];
161     tempD = pdist([antPosnew; tempTag], 'euclidean');
162
163     % Display if tag is in range or not
164     if tempD > r1
165         streamDataRSSI(m) = 0;
166         if (streamDataRSSI(m) ~= streamDataRSSIold(m)) && mode == 2
167             if mode_hex == 1
168                 fprintf(fileID, '%d %s%s%s%d%s\n', l*angle1, text2, dec2hex(m, 16),
169                     text3, k(end), text0);
169             elseif mode_hex == 0
170                 fprintf(fileID, '%d %s%d%s%d%s\n', l*angle1, text2, m, text3, k(end),

```



```

                                text0);
171         end
172         fprintf( ' %d %d %d\n' ,l*angle1 ,m, '0' );
173     end
174     elseif tempD <= r1
175         % disp(['Label ',m_str,' in range !!!!!!!!!!!!!!! ']);
176         % Relation distance <-> RSSI
177         k_temp = find( r2>=tempD );
178         k = r4( k_temp );
179         dataRSSI( timeStep ,m ) = k( end );
180         streamDataRSSI( m ) = k( end );
181         if ( streamDataRSSI( m ) ~= streamDataRSSIold( m ) ) && mode == 2
182             if mode_hex == 1
183                 fprintf( fileID , '%d %s%s%s%d%s\n' ,l*angle1 ,text2 ,dec2hex( m, 16 ) ,
                                text3 ,k( end ) ,text0 );
184             elseif mode_hex == 0
185                 fprintf( fileID , '%d %s%d%s%d%s\n' ,l*angle1 ,text2 ,m ,text3 ,k( end ) ,
                                text0 );
186             end
187             fprintf( ' %d %d %d\n' ,l*angle1 ,m ,k( end ) );
188         elseif mode == 1
189             if mode_hex == 1
190                 fprintf( fileID , '%d %s%s%s%d%s\n' ,l*angle1 ,text2 ,dec2hex( m, 16 ) ,
                                text3 ,k( end ) ,text0 );
191             elseif mode_hex == 0
192                 fprintf( fileID , '%d %s%d%s%d%s\n' ,l*angle1 ,text2 ,m ,text3 ,k( end ) ,
                                text0 );
193             end
194             fprintf( ' %d %d %d\n' ,l*angle1 ,m ,k( end ) );
195         end
196     end
197     end
198     streamDataRSSIold = streamDataRSSI;
199     pause( cycleT/1000 )
200     timeStep = timeStep + 1;
201 end
202 savefig( 'Figure2.fig' );
203 fclose( fileID );
204
205 %% Results
206 % figure(3) % plot for the max value of every tag
207 % dataRSSIinoT = reshape( max( dataRSSI ) , [ numTagsX , numTagsY ] );
208 % plot3( Tagx , Tagy , dataRSSIinoT , '*' );
209 % xlabel( 'Length platform in cm' )
210 % ylabel( 'Width platform in cm' )
211 % title( 'Max RSSI signal of every tag' )
212
213 figure(4) % plot of the RSSI signal which are non zero vs. time
214 dataRSSIsum = sum( dataRSSI );
215 IDclear = find( dataRSSIsum ~= 0 );
216 IDstr = string( IDclear );
217 dataRSSIclear = dataRSSI;
218 dataRSSIclear( :, all( ~any( dataRSSI ) , 1 ) ) = []; % and columns
219 plot( dataRSSIclear );
220 xlabel( 'Measurement points' )
221 ylabel( 'RSSI' )
222 ylim( [0 360/angle1] )
223 legend( IDstr , 'FontSize' , 6 );
224 title( 'RSSI Signal of every non zero tag' )

```

11.2 Appendix B: Receiving data from reader via Wifi (C#)

```
1 using System;
2 using System.Collections.Generic;
3 using System.Linq;
4 using System.Text;
5 using System.Windows;
6 using System.IO;
7 using System.Threading;
8 using System.Net;
9 using System.Net.Sockets;
10 using MULTIFORM_PCS.ControlModules.SchedulingModule;
11 using MULTIFORM_PCS.ControlModules.FeedForwadModule;
12 using MULTIFORM_PCS.ControlModules.RoutingModule.PathAndVelocityPlanning.
    DataTypes;
13 using MULTIFORM_PCS.ControlModules.CameraModule.CameraForm;
14 using MULTIFORM_PCS.ControlModules.CameraControl.CameraControlClass;
15 using System.Windows.Threading;
16 using System.Diagnostics; // Process
17 using System.Globalization;
18 using Emgu.CV.WPF;
19 using System.Threading.Tasks;
20 using System.Collections.Concurrent;
21
22 namespace MULTIFORM_PCS.ControlModules.RFID
23 {
24     public class receive
25     {
26         public string[] availablearray=new string[1];
27         public void connect()
28         {
29             try
30             {
31                 Console.WriteLine("Connecting");
32                 TcpClient tcpClient = new TcpClient("192.168.0.100", 8883);
33                 if (tcpClient.Connected)
34                 {
35                     Console.WriteLine("Connected to server");
36                 }
37             }
38             catch (Exception e)
39             {
40                 Console.WriteLine("Connection Failed");
41             }
42         }
43
44         public void reading(Cancellation token ct)
45         {
46             if (ct.IsCancellationRequested == true)
47             {
48                 ct.ThrowIfCancellationRequested();
49             }
50         }
51     }
52 }
```

```
49     }
50
51     Console.WriteLine("Connecting");
52     TcpClient tcpClient = new TcpClient("192.168.0.100", 8883);
53
54     if (tcpClient.Connected)
55     {
56         Console.WriteLine("Connected to server");
57     }
58
59     using (StreamReader STR = new StreamReader(tcpClient.GetStream()))
60     {
61         string recieve;
62         char[] trash = new char[16];
63         char[] UID = new char[3];
64         char[] RSSI = new char[3];
65         long milliseconds, seconds, minutes;
66         string UID_, RSSI_, RSSI___;
67         string[] array = new string[1];
68
69         List<string> RSSI__;
70         int UID_DEC=0;
71         int RSSI_int = 0;
72
73         while ((recieve = STR.ReadLine()) != null && !ct.
74             IsCancellationRequested)
75         {
76             if (ct.IsCancellationRequested)
77             {
78                 try
79                 {
80                     ct.ThrowIfCancellationRequested();
81                 }
82                 catch (AggregateException e)
83                 {
84                 }
85             }
86
87             if (recieve.Contains("+"))
88             {
89                 List<string> Worte = recieve.Split(new string[] { "OK",
90                     "<\r>", "\n", "", "SCAN:+UID=", "+RSSI=" },
91                     StringSplitOptions.RemoveEmptyEntries).ToList();
92                 string Wort = string.Join("", Worte.ToArray());
93
94                 using (StringReader sr = new StringReader(Wort))
95                 {
96                     sr.Read(trash, 0, 13);
97                     sr.Read(UID, 0, 3);
98                     UID_ = new string(UID);
```

```
97         sr.Read(trash, 0, 1);
98         sr.Read(RSSI, 0, 1);
99         RSSI_ = new string(RSSI);
100         try
101         {
102             UID_DEC = Int32.Parse(UID_, System.Globalization
103                 .NumberStyles.HexNumber);
104         }
105         catch (Exception e)
106         {
107         }
108     }
109     RSSI__ = RSSI_.Split(new string[] { "," },
110         StringSplitOptions.RemoveEmptyEntries).ToList();
111     RSSI___ = string.Join(",", RSSI__.ToArray());
112     try
113     {
114         RSSI_int = Int32.Parse(RSSI___);
115     }
116     catch (Exception e)
117     {
118     }
119     milliseconds = DateTimeOffset.Now.Millisecond;
120     seconds = DateTimeOffset.Now.Second;
121     minutes = DateTimeOffset.Now.Minute;
122     array[0] = minutes + " " + seconds + " " + milliseconds
123         + " " + UID_DEC + " " + RSSI_int;
124     //File.AppendAllText(AppDomain.CurrentDomain.
125         BaseDirectory + "\\pythonfiles\\python_1robot\\
126         RFID_Data.log", minutes + " " + seconds + " " +
127         milliseconds + "\t UID: " + UID_ + " RSSI: " +
128         RSSI___ + "\r");
129     //File.AppendAllText(AppDomain.CurrentDomain.
130         BaseDirectory + "\\pythonfiles\\python_1robot\\
131         RFID_Data_original.log", hour + ":" + minutes + ":"
132         + seconds + ":" + milliseconds + "\t" + recieve + "\r");
133     //Console.WriteLine(minutes + " " + seconds + " " +
134         milliseconds + "\t" + " " + UID_ + " " + RSSI___);
135     }
136     this.availablearray[0] = array[0];
137 }
138 }
139 }
140 }
141 }
142 }
143 }
144 }
145 }
146 }
147 }
148 }
149 }
150 }
151 }
152 }
153 }
154 }
155 }
156 }
157 }
158 }
159 }
160 }
161 }
162 }
163 }
164 }
165 }
166 }
167 }
168 }
169 }
170 }
171 }
172 }
173 }
174 }
175 }
176 }
177 }
178 }
179 }
180 }
181 }
182 }
183 }
184 }
185 }
186 }
187 }
188 }
189 }
190 }
191 }
192 }
193 }
194 }
195 }
196 }
197 }
198 }
199 }
200 }
201 }
202 }
203 }
204 }
205 }
206 }
207 }
208 }
209 }
210 }
211 }
212 }
213 }
214 }
215 }
216 }
217 }
218 }
219 }
220 }
221 }
222 }
223 }
224 }
225 }
226 }
227 }
228 }
229 }
230 }
231 }
232 }
233 }
234 }
235 }
236 }
237 }
238 }
239 }
240 }
241 }
242 }
243 }
244 }
245 }
246 }
247 }
248 }
249 }
250 }
251 }
252 }
253 }
254 }
255 }
256 }
257 }
258 }
259 }
260 }
261 }
262 }
263 }
264 }
265 }
266 }
267 }
268 }
269 }
270 }
271 }
272 }
273 }
274 }
275 }
276 }
277 }
278 }
279 }
280 }
281 }
282 }
283 }
284 }
285 }
286 }
287 }
288 }
289 }
290 }
291 }
292 }
293 }
294 }
295 }
296 }
297 }
298 }
299 }
300 }
301 }
302 }
303 }
304 }
305 }
306 }
307 }
308 }
309 }
310 }
311 }
312 }
313 }
314 }
315 }
316 }
317 }
318 }
319 }
320 }
321 }
322 }
323 }
324 }
325 }
326 }
327 }
328 }
329 }
330 }
331 }
332 }
333 }
334 }
335 }
336 }
337 }
338 }
339 }
340 }
341 }
342 }
343 }
344 }
345 }
346 }
347 }
348 }
349 }
350 }
351 }
352 }
353 }
354 }
355 }
356 }
357 }
358 }
359 }
360 }
361 }
362 }
363 }
364 }
365 }
366 }
367 }
368 }
369 }
370 }
371 }
372 }
373 }
374 }
375 }
376 }
377 }
378 }
379 }
380 }
381 }
382 }
383 }
384 }
385 }
386 }
387 }
388 }
389 }
390 }
391 }
392 }
393 }
394 }
395 }
396 }
397 }
398 }
399 }
400 }
401 }
402 }
403 }
404 }
405 }
406 }
407 }
408 }
409 }
410 }
411 }
412 }
413 }
414 }
415 }
416 }
417 }
418 }
419 }
420 }
421 }
422 }
423 }
424 }
425 }
426 }
427 }
428 }
429 }
430 }
431 }
432 }
433 }
434 }
435 }
436 }
437 }
438 }
439 }
440 }
441 }
442 }
443 }
444 }
445 }
446 }
447 }
448 }
449 }
450 }
451 }
452 }
453 }
454 }
455 }
456 }
457 }
458 }
459 }
460 }
461 }
462 }
463 }
464 }
465 }
466 }
467 }
468 }
469 }
470 }
471 }
472 }
473 }
474 }
475 }
476 }
477 }
478 }
479 }
480 }
481 }
482 }
483 }
484 }
485 }
486 }
487 }
488 }
489 }
490 }
491 }
492 }
493 }
494 }
495 }
496 }
497 }
498 }
499 }
500 }
```

```
136         TcpClient tcpClient = new TcpClient();
137         tcpClient.Connect("192.168.0.100", 8883);
138         tcpClient.Close();
139
140     }
141 }
142 }
```

11.3 Appendix C: Initialization procedure (C#)

```

1 using System;
2 using System.Collections.Generic;
3 using System.Linq;
4 using System.Text;
5 using MULTIFORM_PCS.ControlModules.CameraModule.CameraForm;
6 using System.Threading;
7 using MULTIFORM_PCS.GUI;
8 using MULTIFORM_PCS.Gateway.ConnectionModule;
9 using MULTIFORM_PCS.ControlModules.RFID;
10 using System.Threading.Tasks;
11 using System.Collections;
12
13 namespace MULTIFORM_PCS.ControlModules.MPCModule
14 {
15     public class Position
16     {
17         public int X = 0;
18         public int Y = 0;
19     }
20
21     public class PositionD
22     {
23         public double X = 0;
24         public double Y = 0;
25     }
26
27     class Init
28     {
29         //See Appendix D - I
30     }
31 }

```

11.4 Appendix D: Initialization turn and recording Data(C#)

```

1
2     public static void initialize(Int32 time)
3     {
4         int messungen = 100;
5         //Gateway.ConnectionModule.ConnectionCTRLModule.GetInstance().
6         //    setCTRLForRobot(0, 0.0, 100.0, 0.0, 8.0, 0.0, 0.0, 3.0);
7         receive initial = new receive(); //Create a new instance of
8         //    class Receive
9         var tokenSource = new CancellationTokenSource();
10        var token = tokenSource.Token;
11        Init compare = new Init();
12        string[] rfid_signals = new string[messungen];
13        int currentRobot = 0;
14        int[] RobotAssingment = new int[] { 0, 1, 3 };
15        Gateway.CTRLModule.GetInstance().camCtrl.
16        //    processFrameAndUpdateGUI();

```

```
14 RobotDiscription[] RobotArray = new RobotDiscription[] { Gateway
    .CTRLModule.GetInstance().camCtrl.RobotA, Gateway.CTRLModule
    .GetInstance().camCtrl.RobotB,
15 Gateway.CTRLModule.GetInstance().camCtrl.RobotC };
16 double[][] velocity1 = new double[RobotArray.Length][];
17 string[,] Signals = new string[messungen,8];
18 velocity1[currentRobot] = new double[] { 0, 0 }; //Starts the
    Robot
19 Gateway.CTRLModule.GetInstance().getRobotRemoteCTRL(
    RobotAssingment[currentRobot]).forward(velocity1[
    currentRobot], 0, 0, 0); //Sends velocity to Robot
20 //Opening a new Task which works in the background to read data
    from RFID Antenna
21 Task t = Task.Factory.StartNew(() => initial.reading(token));
22 Thread.Sleep(1000);
23 for (int i = 0; i < 8; i++) //9 Because of 8 measurements
    every 45 degree
24 {
25     for (int j = 0; j < messungen; j++) //in this for loop we
        find all the reachable TAGs
26     {
27         Signals[j, i] = initial.availablearray[0];
28         Thread.Sleep(100);
29     }
30     velocity1[currentRobot] = new double[] { 100, -100 }; //
        Starts the Robot
31 Gateway.CTRLModule.GetInstance().getRobotRemoteCTRL(
    RobotAssingment[currentRobot]).forward(velocity1[
    currentRobot], 0, 0, 0); //Sends velocity to Robot
32 Thread.Sleep(time); //time the robot needs for a 45 degree
    turn
33 velocity1[currentRobot] = new double[] { 0, 0 }; //Stops
    the Robot
34 Gateway.CTRLModule.GetInstance().getRobotRemoteCTRL(
    RobotAssingment[currentRobot]).forward(velocity1[
    currentRobot], 0, 0, 0); //Sends velocity to Robot
35 }
36
37 tokenSource.Cancel(); //close the reading Thread
38 try
39 {
40     Task.WaitAll(t);
41 }
42 catch (AggregateException e)
43 {
44 }
45 finally
46 {
47     tokenSource.Dispose();
48 }
49 Console.WriteLine("END\r\r");
```

```
50
51     Array[] Liste = new Array[8]; //List of arrays each array in the
52     string[,] Init_array = new string[8, 14]; //Array filled with
53     string temp_ID="begin", temp_RSSI; //Substrings of Data
54     int counter; //Counter for the row in the Init_Array
55     Console.WriteLine("");
```

11.5 Appendix E: Filling Array(C#)

```
1 for (int j = 0; j < 8; j++)//converting UID to the specific decimal numbers in
   lookup table
2     {
3         counter = 0;
4         for (int i = 0; i < messungen; i++)
5             {
6                 try
7                 {
8                     temp_ID = Signals[i, j].Substring(Signals[i, j].Length -
9                     6, 4); //seperation of UID in the string
10                    if (temp_ID == "2788")
11                        {
12                            temp_ID = "1";
13                        }
14                    if (temp_ID == "1414")
15                        {
16                            temp_ID = "2";
17                        }
18                    if (temp_ID == "3060")
19                        {
20                            temp_ID = "3";
21                        }
22                    if (temp_ID == "1673")
23                        {
24                            temp_ID = "4";
25                        }
26                    if (temp_ID == "1925" || temp_ID == "1025")
27                        {
28                            temp_ID = "5";
29                        }
30                    if (temp_ID == "1681")
31                        {
32                            temp_ID = "6";
33                        }
34                    if (temp_ID == "1146")
35                        {
36                            temp_ID = "7";
37                        }
38                    if (temp_ID == "2780")
39                        {
40                            temp_ID = "8";
```



```

40         }
41         if (temp_ID == "1933")
42         {
43             temp_ID = "9";
44         }
45     }
46     catch (AggregateException e)
47     {
48         Console.WriteLine("Array incomplete");
49     }
50
51     temp_RSSI = Signals[i, j].Substring(Signals[i, j].Length -
52     1, 1); //seperation of RSSI in the string
53     if (temp_ID != Init_array[j, 0] && temp_ID != Init_array[j,
54     1] && temp_ID != Init_array[j, 2] && temp_ID !=
55     Init_array[j, 3] && temp_ID != Init_array[j, 4] &&
56     temp_ID != Init_array[j, 5] && temp_ID != Init_array[j,
57     6] && temp_ID != Init_array[j, 7]) //check if the UID
58     already exists in the Init_array
59     {
60         //Filling Init_Array
61         Init_array[j, counter] = temp_ID;
62         Init_array[j, counter + 7] = temp_RSSI;
63         counter++;
64     }
65 }
66 }

```

11.6 Appendix F: Checking for solutions in array(C#)

```

1  int rowLength = Init_array.GetLength(0);
2  int collLength = Init_array.GetLength(1);
3  string str;
4  string headline = "|" + "ID 1" + "|" + "ID 2" + "|" + "ID 3" + "
5  |" + "ID 4" + "|" + "ID 5" + " | " + "ID 6" + "|" + "ID 7" +
6  "|" + "ST 1" + "|" + "ST 2" + "|" + "ST 3" + "|" + "ST 4" +
7  "|" + "ST 5" + "|" + "ST 6" + "|" + "ST 7" + "|";
8  System.Console.WriteLine(headline);
9
10 for (int k = 0; k < rowLength; k++)
11 {
12     str = "|" + Init_array[k, 0] + "    |" + Init_array[k, 1] + "
13     |" + Init_array[k, 2] + "    |" + Init_array[k, 3] + "
14     |" + Init_array[k, 4] + "    |" + Init_array[k, 5] + "
15     |" + Init_array[k, 6] + "    |" + Init_array[k, 7] + "
16     |" + Init_array[k, 8] + "    |" + Init_array[k, 9] + "
17     |" + Init_array[k, 10] + "    |" + Init_array[k, 11] +
18     "    |" + Init_array[k, 12] + "    |" + Init_array[k, 13]
19     + "    |";
20     System.Console.WriteLine(str);
21 }

```

```
13         // Solver
14         // Different Positions
15         Position Starting = new Position();
16         Position Antenna1 = new Position();
17         Position Antenna2 = new Position();
18         Position Antenna3 = new Position();
19         Position Antenna4 = new Position();
20
21         //Initialization for Position estimation
22         float m1 = 0.000f;
23         float m2 = 0.000f;
24
25         float RobStartx_fl = 0.000f;
26         float RobStarty_fl = 0.000f;
27
28         double angle;
29         double angleTemp;
30
31         int null_counter = 0;
32         int[] check_row = new int[8];
33         for (int m = 0; m < rowLength; m++)
34         {
35             null_counter = 0;
36             for (int n = 0; n < 7; n++)
37             {
38                 if (Init_array[m, n] == null)
39                 {
40                     null_counter++;
41                 }
42             }
43             check_row[m] = 7 - null_counter;    //Array of elements with
44             System.Console.WriteLine("The number of elements at " + m *
45             45 + "° is: \t" + check_row[m]);
46         }
47         bool solution_found = false;    //true if initialization process
48             is solvable
49         bool solution1_found = false;    //true if one possible point is
50             found
51         bool solution2_found = false;    //true if two possible points
52             are found
53         int count = 0;
54         int[] solution1 = new int[2];    //Array with the both degree
55             numbers of solution 1
56         int[] solution2 = new int[2];    //Array with the both degree
57             numbers of solution 2
58         while (solution_found == false)
59         {
60             while (solution1_found == false)
61             {
62                 if (check_row[count] >= 3)
```

```
57         {
58             if (check_row[count + 4] >= 3)
59             {
60                 solution1[0] = count;
61                 solution1[1] = count + 4;
62                 break;
63             }
64             if (count >= 2) //if we reach the 180 degree
                             there will be no solution for this
                             initialization turn
65             {
66                 System.Console.WriteLine("NO SOLUTION FOUND!!!")
67                 ;
68                 break;
69             }
70             count++;
71         }
72         System.Console.WriteLine(count);
73         count = count + 1;
74         while (solution2_found == false)
75         {
76             if (check_row[count] >= 3)
77             {
78                 if (count >= 8)
79                 {
80                     Console.WriteLine("Out of Range Exception caused
81                                     in Array: count");
82                 }
83                 if (check_row[count + 4] >= 3)
84                 {
85                     solution2[0] = count;
86                     solution2[1] = count + 4;
87                     solution_found = true;
88                     break;
89                 }
90                 if (count >= 3) //if we reach the 180 degree
91                                     there will be no solution for this
92                                     initialization turn
93                 {
94                     System.Console.WriteLine("NO SOLUTION FOUND!!!")
95                     ;
96                     break;
97                 }
98                 else
99                 {
100                    //count = count - 1;
101                    break;
102                }
103            }
104        }
```

```

101         System.Console.WriteLine("Solution No. 1 found at: " +
            solution1[0] * 45 + " degree -- " + solution1[1] * 45 +
            " degree");
102         System.Console.WriteLine("Solution No. 2 found at: " +
            solution2[0] * 45 + " degree -- " + solution2[1] * 45 +
            " degree");
103     }

```

11.7 Appendix G: Position and orientation estimation(C#)

```

1 // Providing the distance with the highest probability
2 // Input: # of tags, all IDs of the tags
3 // Output: best fitting IDs (e.g.[3 4 5] if 3rd, 4th and 5th
4 //         are best ones)
5 //         the correct distance <-> RSSI signal (e.g.[2 1 3]
6 //         for middle, max and min)
7 int[,] best_arr1 = new int[2, 3];
8 int[,] best_arr2 = new int[2, 3];
9 int[,] best_arr3 = new int[2, 3];
10 int[,] best_arr4 = new int[2, 3];
11
12 int[] temp_input1 = new int[7];
13 int[] temp_input2 = new int[7];
14 int[] temp_input3 = new int[7];
15 int[] temp_input4 = new int[7];
16
17 int[] temp_inputRSSI1 = new int[7];
18 int[] temp_inputRSSI2 = new int[7];
19 int[] temp_inputRSSI3 = new int[7];
20 int[] temp_inputRSSI4 = new int[7];
21
22 for (int i = 0; i < 8; i++)
23 {
24     for (int j = 0; j < 14; j++)
25     {
26         if (Init_array[i, j] == null)
27         {
28             Init_array[i, j] = "0";
29         }
30     }
31 }
32
33 for (int m = 0; m < 7; m++)
34 {
35     temp_input1[m] = Int32.Parse(Init_array[solution1[0], m]);
36     temp_input2[m] = Int32.Parse(Init_array[solution1[1], m]);
37     temp_input3[m] = Int32.Parse(Init_array[solution2[0], m]);
38     temp_input4[m] = Int32.Parse(Init_array[solution2[1], m]);
39
40     temp_inputRSSI1[m] = Int32.Parse(Init_array[solution1[0], m
41         + 7]);

```

```
39         temp_inputRSSI2[m] = Int32.Parse(Init_array[solution1[1], m
40             + 7]);
41         temp_inputRSSI3[m] = Int32.Parse(Init_array[solution2[0], m
42             + 7]);
43         temp_inputRSSI4[m] = Int32.Parse(Init_array[solution2[1], m
44             + 7]);
45     }
46
47     best_arr1 = CorrectID_Distance(temp_input1, temp_inputRSSI1,
48         check_row[solution1[0]]);
49     best_arr2 = CorrectID_Distance(temp_input2, temp_inputRSSI2,
50         check_row[solution1[1]]);
51     best_arr3 = CorrectID_Distance(temp_input3, temp_inputRSSI3,
52         check_row[solution2[0]]);
53     best_arr4 = CorrectID_Distance(temp_input4, temp_inputRSSI4,
54         check_row[solution2[1]]);
55
56     // Position of the antennae
57     Antenna1 = Trilateration(IDtoPOS(Int32.Parse(Init_array[
58         solution1[0], best_arr1[0, 0]])), IDtoPOS(Int32.Parse(
59         Init_array[solution1[0], best_arr1[0, 1]])),
60         IDtoPOS(Int32.Parse(Init_array[solution1
61             [0], best_arr1[0, 2]])), Int32.Parse(
62             Init_array[solution1[0], best_arr1
63                 [0, 0] + 7]),
64             Int32.Parse(Init_array[solution1[0],
65                 best_arr1[0, 1] + 7]), Int32.Parse(
66                 Init_array[solution1[0], best_arr1
67                     [0, 2] + 7]),
68             best_arr1[1, 0], best_arr1[1, 1],
69             best_arr1[1, 2]);
70
71     Antenna2 = Trilateration(IDtoPOS(Int32.Parse(Init_array[
72         solution1[1], best_arr2[0, 0]])), IDtoPOS(Int32.Parse(
73         Init_array[solution1[1], best_arr2[0, 1]])),
74         IDtoPOS(Int32.Parse(Init_array[solution1
75             [1], best_arr2[0, 2]])), Int32.Parse(
76             Init_array[solution1[1], best_arr2
77                 [0, 0] + 7]),
78             Int32.Parse(Init_array[solution1[1],
79                 best_arr2[0, 1] + 7]), Int32.Parse(
80                 Init_array[solution1[1], best_arr2
81                     [0, 2] + 7]),
82             best_arr2[1, 0], best_arr2[1, 1],
83             best_arr2[1, 2]);
84
85     Antenna3 = Trilateration(IDtoPOS(Int32.Parse(Init_array[
86         solution2[0], best_arr3[0, 0]])), IDtoPOS(Int32.Parse(
87         Init_array[solution2[0], best_arr3[0, 1]])),
88         IDtoPOS(Int32.Parse(Init_array[solution2
89             [0], best_arr3[0, 2]])), Int32.Parse(
90             Init_array[solution2[0], best_arr3[0, 0] + 7]),
91             Int32.Parse(Init_array[solution2[0],
92                 best_arr3[0, 1] + 7]), Int32.Parse(
93                 Init_array[solution2[0], best_arr3
94                     [0, 2] + 7]),
95             best_arr3[1, 0], best_arr3[1, 1],
96             best_arr3[1, 2]);
```

```

        (Init_array[solution2[0], best_arr3
62         [0, 0] + 7]),
        Int32.Parse(Init_array[solution2[0],
        best_arr3[0, 1] + 7]), Int32.Parse(
        Init_array[solution2[0], best_arr3
63         [0, 2] + 7]),
        best_arr3[1, 0], best_arr3[1, 1],
        best_arr3[1, 2]);
64
65     Antenna4 = Trilateration(IDtoPOS(Int32.Parse(Init_array[
        solution2[1], best_arr4[0, 0]])), IDtoPOS(Int32.Parse(
        Init_array[solution2[1], best_arr4[0, 1]])),
66         IDtoPOS(Int32.Parse(Init_array[solution2
        [1], best_arr4[0, 2]])), Int32.Parse(
        Init_array[solution2[1], best_arr4
        [0, 0] + 7]),
67         Int32.Parse(Init_array[solution2[1],
        best_arr4[0, 1] + 7]), Int32.Parse(
        Init_array[solution2[1], best_arr4
        [0, 2] + 7]),
68         best_arr4[1, 0], best_arr4[1, 1],
        best_arr4[1, 2]);
69
70     Console.WriteLine("1st Antenna " + Antenna1.X + " and " +
        Antenna1.Y);
71     Console.WriteLine("2nd Antenna " + Antenna2.X + " and " +
        Antenna2.Y);
72     Console.WriteLine("3rd Antenna " + Antenna3.X + " and " +
        Antenna3.Y);
73     Console.WriteLine("4th Antenna " + Antenna4.X + " and " +
        Antenna4.Y);
74
75     //Console.ReadKey();
76     // Alternative estimation of the centre of the robot + position
77     //m1 = ((float)Antenna2.Y - (float)Antenna1.Y) / ((float)
        Antenna2.X - (float)Antenna1.X);
78     //m2 = ((float)Antenna4.Y - (float)Antenna3.Y) / ((float)
        Antenna4.X - (float)Antenna3.X);
79     //RobStartx_fl = (1 / (m1 - m2)) * (m1 * (float)Antenna1.X - m2
        * (float)Antenna3.X - (float)Antenna1.Y + (float)Antenna3.Y)
        ;
80     //RobStarty_fl = m1 * (RobStartx_fl - (float)Antenna1.X) + (
        float)Antenna1.Y;
81
82     //Starting.X = (int)RobStartx_fl;
83     //Starting.Y = (int)RobStarty_fl;
84
85     Starting.X = (((Antenna4.X-Antenna3.X)*(Antenna2.X*Antenna1.Y-
        Antenna1.X*Antenna2.Y)-(Antenna2.X-Antenna1.X)*(Antenna4.X*
        Antenna3.Y-Antenna3.X*Antenna4.Y)) /
86         ((Antenna4.Y - Antenna3.Y) * (Antenna2.X -

```

```

87         Antenna1.X) - (Antenna2.Y - Antenna1.Y)
            * (Antenna4.X - Antenna3.X));
Starting.Y = (((Antenna1.Y - Antenna2.Y) * (Antenna4.X *
Antenna3.Y - Antenna3.X * Antenna4.Y) - (Antenna3.Y -
Antenna4.Y) * (Antenna2.X * Antenna1.Y - Antenna1.X *
Antenna2.Y)) /
88         ((Antenna4.Y - Antenna3.Y) * (Antenna2.X -
Antenna1.X) - (Antenna2.Y - Antenna1.Y)
            * (Antenna4.X - Antenna3.X)));
89
90     Console.WriteLine("Robotstarting Position at:" + Starting.X + "
mm, " + Starting.Y + "mm");
91
92     // Computing the orientation of the Robot
93     //angle = (Math.Atan2(y, x)) * (180 / Math.PI);
94     angleTemp = (Math.Atan2((Antenna1.Y - Starting.Y), (Antenna1.X -
Starting.X))) * (180 / Math.PI);
95     Console.WriteLine("Angle temp " + angleTemp);
96     angle = angleTemp - (double)(solution1[0]*45.0); // in deg
97     Console.WriteLine("Angle wrong direction " + angle);
98     if (angle <= 0.0)
99     {
100         angle = angle + 180;
101     }
102     else
103     {
104         angle = angle - 180;
105     }
106
107     Console.WriteLine("Robotangle: " + angle + "Â°");
108
109 }

```

11.8 Appendix H: Initialization procedure 3(C#)

```

1 // Procedure and function
2 //Methode to compute the position based on the ID in [cm], Output in [mm]
3     public static Position Trilateration(Position point1, Position point2,
Position point3, int r1t, int r2t, int r3t, int bestr1, int bestr2,
int bestr3)
4     {
5         //double[] dist = new double[] { 10.5, 10.0, 9.5, 9.0, 8.0, 6.0,
5.0, 4.0 }; // FH paper
6         double[,] dist = new double[3, 8] { { 14, 9.75, 9.0, 8.0, 7.0, 6.0,
3.5, 2.75 },
7                                     { 5.0, 5.1, 5.3, 5.5, 5.8, 4.0,
3.5, 2.75 },
8                                     { 5.0, 4.7, 4.5, 4.3, 4.2, 4.0,
3.5, 2.75} }; //
Approximation of our
measurements
9

```

```
10         Position resultPose = new Position();
11         PositionD ex = new PositionD();
12         PositionD ey = new PositionD();
13         PositionD aux = new PositionD();
14         PositionD auy = new PositionD();
15         PositionD aux2 = new PositionD();
16         double r1;
17         double r2;
18         double r3;
19         r1 = dist[best1, r1t];
20         r2 = dist[best2, r2t];
21         r3 = dist[best3, r3t];
22
23         // For testing purpose
24         //Console.WriteLine("1st radius " + r1);
25         //Console.WriteLine("2nd radius " + r2);
26         //Console.WriteLine("3rd radius " + r3);
27
28         //Console.WriteLine("1st point " + point1.X + " " + point1.Y);
29         //Console.WriteLine("2nd point " + point2.X + " " + point2.Y);
30         //Console.WriteLine("3rd point " + point3.X + " " + point3.Y);
31
32         //unit vector in a direction from point1 to point 2
33         double p2p1Distance = Math.Pow(Math.Pow(point2.X - point1.X, 2) +
34             Math.Pow(point2.Y - point1.Y, 2), 0.5);
35         ex.X = (point2.X - point1.X) / p2p1Distance;
36         ex.Y = (point2.Y - point1.Y) / p2p1Distance;
37         aux.X = point3.X - point1.X;
38         aux.Y = point3.Y - point1.Y;
39         //signed magnitude of the x component
40         double i = ex.X * aux.X + ex.Y * aux.Y;
41         //the unit vector in the y direction.
42         aux2.X = point3.X - point1.X - i * ex.X;
43         aux2.Y = point3.Y - point1.Y - i * ex.Y;
44         ey.X = aux2.X / Norm(aux2);
45         ey.Y = aux2.Y / Norm(aux2);
46         //the signed magnitude of the y component
47         double j = ey.X * aux.X + ey.Y * aux.Y;
48         //coordinates
49         double x = (Math.Pow(r1, 2) - Math.Pow(r2, 2) + Math.Pow(
50             p2p1Distance, 2)) / (2 * p2p1Distance);
51         double y = (Math.Pow(r1, 2) - Math.Pow(r3, 2) + Math.Pow(i, 2) +
52             Math.Pow(j, 2)) / (2 * j) - i * (x / j);
53         //result coordinates
54         double finalX = 10 * (point1.X + x * ex.X + y * ey.X);
55         double finalY = 10 * (point1.Y + x * ex.Y + y * ey.Y);
56         resultPose.X = (int)(finalX);
57         resultPose.Y = (int)(finalY);
58
59         return resultPose;
60     }
```

11.9 Appendix I: Initialization procedure 4(C#)

```

1
2 // Method to compute the norm of a vector
3 public static double Norm(PositionD p) // get the norm of a vector
4 {
5     return (Math.Pow(Math.Pow(p.X, 2) + Math.Pow(p.Y, 2), 0.5));
6 }
7
8 // Methode to compute the position based on the ID in [mm]
9 public static Position IDtoPOS(int ID)
10 {
11     Position FinalPos = new Position();
12     int[] posx = new int[9] { 10, 10, 10, 20, 20, 20, 30, 30, 30 };
13     int[] posy = new int[9] { 10, 20, 30, 10, 20, 30, 10, 20, 30 };
14     // For a 3x3 testing field
15     FinalPos.X = posx[ID - 1];
16     FinalPos.Y = posy[ID - 1];
17     return FinalPos;
18 }

```

11.10 Appendix J: Initialization procedure 5(C#)

```

1 // Find neighbours of the IDs
2 public static int[] FindNeig(int[] arrID, int numTags)
3 {
4     // Init
5     int[] neighbours = new int[numTags];
6     int[] tempNeig = new int[4];
7
8     // Find the number of neighbours
9     for (int m = 0; m < numTags; m++)
10    {
11        // Init
12        neighbours[m] = 0;
13
14        // Take actual ID and compute the possible neighbours
15        tempNeig[0] = arrID[m] - 11;
16        tempNeig[1] = arrID[m] - 1;
17        tempNeig[2] = arrID[m] + 1;
18        tempNeig[3] = arrID[m] + 11;
19
20        for (int v = 0; v < 4; v++)
21        {
22            foreach (int tempinput in arrID)
23            {
24                if (tempinput == tempNeig[v])
25                {
26                    neighbours[m] += 1;
27                }
28            }
29        }

```

```

30     }
31     return neighbours;
32 }

```

11.11 Appendix K: Initialization procedure 6(C#)

```

1 // Methode to compute the best IDs and correct distances
2 public static int[,] CorrectID_Distance(int[] arr, int[] arrRSSI, int
   numTags)
3 {
4     // Inputs
5     /* arr = Array of all IDs
6      * arrRSSI = Array of all RSSI
7      * numTags = Int with the num of tags found
8     */
9     // Init
10    int[,] best = new int[2, 3];
11    int[] dist = new int[numTags]; // Array which contain the
   best distance (max(0),middle(1),min(2))
12    int[] neighbours = new int[numTags];
13    int i = 0;
14    int p = 4;
15
16    // Compute the neighbours
17    neighbours = FindNeig(arr, numTags);
18
19
20    // Switch case for the different possible shapes
21    switch (numTags)
22    {
23        case 3:
24            Console.WriteLine("3 Tags -----");
25            for (int l = 0; l < neighbours.GetLength(0); l++)
26            {
27                if (neighbours[l] == 0) // Detect outlier and
   boarder
28                {
29                    dist[l] = 1; // stay max
30                }
31                else if (neighbours[l] <= 3) // Detect outlier and
   boarder
32                {
33                    dist[l] = 0; // stay max
34                }
35                else if (neighbours[l] == 4) // Detect the inner,
   change it to min/middle
36                {
37                    dist[l] = 1; // change it to middle
38                }
39                else if (neighbours[l] > 4) // Detect the inner,
   change it to min/middle
40                {

```

```

41         dist[1] = 0;           // change it to middle
42     }
43     // all other numbers are at the boarder
44 }
45 // Select the best 3 readings
46 i = 0;
47 p = 4;
48 while (i < 3)                 // Start for the first ID
49 {
50     for (int h = 0; h < neighbours.GetLength(0); h++) //
51         looks for a fitting
52     {
53         if (neighbours[h] == p && i < 3) // hit must be
54             same value and less then 3 hits
55         {
56             best[0, i] = h;           // index of the
57                 best ID
58             best[1, i] = dist[h];    // info about
59                 max, mid and min of this ID
60             i += 1;
61         }
62     }
63     p -= 1;
64 }
65 break;
66 /*
-----
*/
67 case 4:
68     Console.WriteLine("4 Tags -----");
69     for (int l = 0; l < neighbours.GetLength(0); l++)
70     {
71         if (neighbours[l] == 0) // Detect outlier and
72             boarder
73         {
74             dist[1] = 1;           // stay max
75         }
76         else if (neighbours[l] <= 3) // Detect outlier and
77             boarder
78         {
79             dist[1] = 0;           // stay max
80         }
81         else if (neighbours[l] == 4) // Detect the inner,
82             change it to min/middle
83         {
84             dist[1] = 1;           // change it to middle
85         }
86     }

```

```

83         else if (neighbours[l] > 4)           // Detect the inner,
84             change it to min/middle
85         {
86             dist[l] = 0;                       // change it to middle
87         }
88         // all other numbers are at the boarder
89     }
90     // Select the best 3 readings
91     i = 0;
92     p = 4;
93     while (i < 3)                             // Start for the first ID
94     {
95         for (int h = 0; h < neighbours.GetLength(0); h++) //
96             looks for a fitting
97         {
98             if (neighbours[h] == p && i < 3)    // hit must be
99                 same value and less then 3 hits
100            {
101                best[0, i] = h;                 // index of the
102                best ID
103                best[1, i] = dist[h];          // info about
104                max, mid and min of this ID
105                i += 1;
106            }
107            else if (i >= 3)
108            {
109                break;
110            }
111        }
112        p -= 1;
113    }
114
115     break;
116
117     /*
118     -----
119     */
120     case 5:
121     Console.WriteLine("5 Tags -----");
122     for (int l = 0; l < neighbours.GetLength(0); l++)
123     {
124         if (neighbours[l] <= 2)           // Detect outlier and
125             boarder
126         {
127             dist[l] = 0;                   // stay max
128         }
129         else if (neighbours[l] == 3)     // Detect the inner,
130             change it to min/middle
131         {
132             dist[l] = 1;                   // change it to middle
133         }
134         // all other numbers are at the boarder

```

```

125     }
126     // Select the best 3 readings
127     i = 0;
128     p = 4;
129     while (i < 3)                // Start for the first ID
130     {
131         for (int h = 0; h < neighbours.GetLength(0); h++) //
132             looks for a fitting
133         {
134             if (neighbours[h] == p && i < 3) // hit must be
135                 same value and less then 3 hits
136             {
137                 best[0, i] = h;                // index of the
138                     best ID
139                 best[1, i] = dist[h];        // info about
140                     max, mid and min of this ID
141                 i += 1;
142             }
143             else if (i >= 3)
144             {
145                 break;
146             }
147         }
148         p -= 1;
149     }
150     break;
151 }
152
153 /*
154 -----
155 */
156 case 6:
157     Console.WriteLine("6 Tags -----");
158     switch (neighbours.Sum())
159     {
160     case 12: // Shape with 2 outliers
161         Console.WriteLine("2 Outliers");
162         for (int l = 0; l < neighbours.GetLength(0); l++)
163         {
164             if (neighbours[l] <= 2) // Detect outlier
165                 and boarder
166             {
167                 dist[l] = 0; // stay max
168             }
169             else if (neighbours[l] == 4) // Detect the
170                 inner, change it to min/middle
171             {
172                 if (arrRSSI[l] <= 3)
173                 {
174                     dist[l] = 2; // change it to
175                         min
176                 }
177             }
178         }
179     }

```

```
167         else if (arrRSSI[l] > 3)
168             {
169                 dist[l] = 1;           // change it to
                                     middle
170             }
171         }
172         // all other numbers are at the boarder
173     }
174     break;
175 case 14: // Shape like a domino
176     Console.WriteLine("Domino");
177     for (int l = 0; l < neighbours.GetLength(0); l++)
178     {
179         if (neighbours[l] <= 2)      // Detect outlier
                                     and boarder
180         {
181             dist[l] = 0;           // stay max
182         }
183         else if (neighbours[l] == 3) // Detect the
                                     centre, change it to min
184         {
185             dist[l] = 2;           // change it to min
186         }
187         // all other numbers are at the boarder
188     }
189     break;
190 default:
191     Console.WriteLine("Default case");
192     break;
193 }
194 // Select the best 3 readings
195 i = 0;
196 p = 4;
197 while (i < 3)                       // Start for the first ID
198 {
199     for (int h = 0; h < neighbours.GetLength(0); h++) //
                                     looks for a fitting
200     {
201         if (neighbours[h] == p && i < 3) // hit must be
                                     same value and less then 3 hits
202         {
203             best[0, i] = h;           // index of the
                                     best ID
204             best[1, i] = dist[h];    // info about
                                     max, mid and min of this ID
205             i += 1;
206         }
207         else if (i >= 3)
208         {
209             break;
210         }
211     }
```

```
211     }
212     p -= 1;
213 }
214
215 break;
216 /*
-----
*/
217 case 7:
218     Console.WriteLine("7 Tags -----");
219     for (int l = 0; l < neighbours.GetLength(0); l++)
220     {
221         if (neighbours[l] <= 3) // Detect outlier and
222             boarder
223         {
224             dist[l] = 0; // stay max
225         }
226         else if (neighbours[l] == 4) // Detect the centre,
227             change it to min
228         {
229             dist[l] = 2; // change it to min
230         }
231         // all other numbers are at the boarder
232     }
233     // Select the best 3 readings
234     i = 0;
235     p = 4;
236     while (i < 3) // Start for the first ID
237     {
238         for (int h = 0; h < neighbours.GetLength(0); h++) //
239             looks for a fitting
240         {
241             if (neighbours[h] == p && i < 3) // hit must be
242                 same value and less then 3 hits
243             {
244                 best[0, i] = h; // index of the
245                     best ID
246                 best[1, i] = dist[h]; // info about
247                     max, mid and min of this ID
248                 i += 1;
249             }
250             else if (i >= 3)
251             {
252                 break;
253             }
254         }
255         p -= 1;
256     }
257     break;
258 default:
259     Console.WriteLine("Default case");
```

```

254         break;
255     }
256     foreach (int ee in best)
257     {
258         Console.WriteLine(ee);
259     }
260     return best;
261 }

```

11.12 Appendix L: Initialization procedure 7(C#)

```

1 //Methode to compute the position based on the ID in [cm], Output in [mm]
2 public static Position Trilateration(Position point1, Position point2,
3   Position point3, int r1t, int r2t, int r3t, int bestr1, int bestr2,
4   int bestr3)
5 {
6     //double[] dist = new double[] { 10.5, 10.0, 9.5, 9.0, 8.0, 6.0,
7     //    5.0, 4.0 }; // FH paper
8     double[,] dist = new double[3, 8] { { 14, 9.75, 9.0, 8.0, 7.0, 6.0,
9     //    3.5, 2.75 },
10    //    { 5.0, 5.1, 5.3, 5.5, 5.8, 4.0,
11    //    3.5, 2.75 },
12    //    { 5.0, 4.7, 4.5, 4.3, 4.2, 4.0,
13    //    3.5, 2.75} }; //
14    //    Approximation of our
15    //    measurements
16
17     Position resultPose = new Position();
18     PositionD ex = new PositionD();
19     PositionD ey = new PositionD();
20     PositionD aux = new PositionD();
21     PositionD auy = new PositionD();
22     PositionD aux2 = new PositionD();
23     double r1;
24     double r2;
25     double r3;
26     r1 = dist[best1, r1t];
27     r2 = dist[best2, r2t];
28     r3 = dist[best3, r3t];
29
30     // For testing purpose
31     //Console.WriteLine("1st radius " + r1);
32     //Console.WriteLine("2nd radius " + r2);
33     //Console.WriteLine("3rd radius " + r3);
34
35     //Console.WriteLine("1st point " + point1.X + " " + point1.Y);
36     //Console.WriteLine("2nd point " + point2.X + " " + point2.Y);
37     //Console.WriteLine("3rd point " + point3.X + " " + point3.Y);
38
39     //unit vector in a direction from point1 to point 2
40     double p2p1Distance = Math.Pow(Math.Pow(point2.X - point1.X, 2) +
41     Math.Pow(point2.Y - point1.Y, 2), 0.5);

```



```
33     ex.X = (point2.X - point1.X) / p2p1Distance;
34     ex.Y = (point2.Y - point1.Y) / p2p1Distance;
35     aux.X = point3.X - point1.X;
36     aux.Y = point3.Y - point1.Y;
37     //signed magnitude of the x component
38     double i = ex.X * aux.X + ex.Y * aux.Y;
39     //the unit vector in the y direction.
40     aux2.X = point3.X - point1.X - i * ex.X;
41     aux2.Y = point3.Y - point1.Y - i * ex.Y;
42     ey.X = aux2.X / Norm(aux2);
43     ey.Y = aux2.Y / Norm(aux2);
44     //the signed magnitude of the y component
45     double j = ey.X * aux.X + ey.Y * aux.Y;
46     //coordinates
47     double x = (Math.Pow(r1, 2) - Math.Pow(r2, 2) + Math.Pow(
48         p2p1Distance, 2)) / (2 * p2p1Distance);
49     double y = (Math.Pow(r1, 2) - Math.Pow(r3, 2) + Math.Pow(i, 2) +
50         Math.Pow(j, 2)) / (2 * j) - i * (x / j);
51     //result coordinates
52     double finalX = 10 * (point1.X + x * ex.X + y * ey.X);
53     double finalY = 10 * (point1.Y + x * ex.Y + y * ey.Y);
54     resultPose.X = (int)(finalX);
55     resultPose.Y = (int)(finalY);
56     return resultPose;
}
```

11.13 Appendix M: WiFi Initialization WeMos D1 Mini (Arduino)

```

1 #include <SoftwareSerial.h>
2 #include <ESP8266WiFi.h>
3 #include <ESP8266HTTPClient.h>
4 #include <string.h>
5 #include <ArduinoJson.h>
6
7
8 //how many clients should be able to telnet to this ESP8266
9 #define MAX_SRV_CLIENTS 2
10
11 // Definig Wifi address, password, host and port
12 //const char* ssid      = "UPC113C854 A.Abouelkhair";    // write SSID between "(
    here )"
13 //const char* password = "rnU3cu6dzpkA";              // write Password between
    "(case sensitive)"
14 //const char* ssid      = "iPhone";                    // write SSID between "(
    here )"
15 //const char* password = "boody123";                  // write Password between
    "(case sensitive)"
16 const char* ssid      = "iRobot";                      // write SSID between "( here
    )"
17 const char* password = "nopipes123";                  // write Password between "(
    case sensitive)"
18 //const char* ssid      = "DORTMUND-DEMO-AP";          // write SSID
    between "( here )"
19 //const char* password = "ROb0tn1K";                  // write Password between "(
    case sensitive)"
20
21 // Starting Wifi Server and client with Port 8883
22 WiFiServer server(8883);
23 WiFiClient serverClients[MAX_SRV_CLIENTS];
24
25 // Variables Declaration
26 unsigned long previousMillis = 0;
27 const long interval = 10;
28 unsigned long currentTime;
29
30 /* RFID Intialization */
31 SoftwareSerial RFID(14, 12, false, 256);    //RX,TX = D5,D6 (Wemos UART1)

```

11.14 Appendix N: Launch the communication)

```

1 void setup() {
2     /* Beginning Serial Communication with RFID with baud rate 115200 */
3     RFID.begin(115200);
4     // delay(10);
5     // Beginning Serial Communication with baud rate 115200
6     Serial.begin(115200);
7     // delay(10);
8     Serial.println();

```

```
9
10
11 Serial.println();
12 Serial.print("Connecting to ");
13 Serial.println(ssid);
14
15 // Time is used so the device does not stuck in
16 // connecting to Wifi forever
17 currentTime = millis();
18 unsigned long previousTime = currentTime;
19 while (WiFi.status() != WL_CONNECTED) {
20     delay(500);
21     Serial.print(".");
22     currentTime = millis();
23     if ((currentTime - previousTime) > 12000) {
24         break;
25     }
26 }
27
28
29 WiFi.mode(WIFI_STA);
30 WiFi.begin(ssid, password);
31 uint8_t i = 0;
32 while (WiFi.status() != WL_CONNECTED && i++ < 20) delay(500);
33 if (i == 21) {
34     Serial.print("Could not connect to"); Serial.println(ssid);
35     while (1) delay(500);
36 }
37 server.begin();
38 server.setNoDelay(true);
39
40
41 // Getting the MAC address and saving it
42 if (WiFi.status() == WL_CONNECTED) {
43     Serial.println("");
44     Serial.println("WiFi connected");
45     Serial.print("IP address: ");
46     Serial.println(WiFi.localIP());
47     Serial.println("Port: 8883");
48 }
49
50 /* AUTO Send AT Command to the RFID */
51 RFID.write("AT+Scan=OFF\r");
52 // RFID.write("AT+Scan=AC,RSSI\r");
53 RFID.write("AT+Scan=AC,RSSI\r");
54
55 // delay(10);
56
57
58 }
```

11.15 Appendix O: Receiving data from RFID reader

```

1 void loop() {
2   // put your main code here, to run repeatedly
3
4   // while(RFID.available())
5   // {
6   //   char read= RFID.read();
7   //   Serial.print(read);
8   //   delay(10);
9   //   }
10
11   /*Send commands Through Wifi*/
12   sendCommandsWiFi();
13
14   /* send AT Commands to RFID through serial monitor */
15   //Example: AT+Scan=AC,RSSI           "Without /r"
16   // Comment the next command if you are using AUTO command send
17   sendCommandsRFID();
18
19
20 }

```

11.16 Appendix P: Publishing tags IDs through the network

```

1 void sendCommandsWiFi()
2 {
3
4   unsigned long currentMillis = millis();
5   uint8_t i;
6   //check if there are any new clients
7   if (server.hasClient()) {
8     for (i = 0; i < MAX_SRV_CLIENTS; i++) {
9       //find free/disconnected spot
10      if (!serverClients[i] || !serverClients[i].connected()) {
11        if (serverClients[i]) serverClients[i].stop();
12        serverClients[i] = server.available();
13        continue;
14      }
15    }
16    //no free/disconnected spot so reject
17    WiFiClient serverClient = server.available();
18    serverClient.stop();
19  }
20
21  //do every 2ms edit from time interval in Declaration
22  // if (currentMillis - previousMillis >= interval) //
23  // { //
24  //   previousMillis = currentMillis; //
25  //   for (i = 0; i < MAX_SRV_CLIENTS; i++)
26  //   {
27  //     if (serverClients[i] && serverClients[i].connected())

```

```
28     {
29     //         delay(20);
30     //         RFID.write("AT+A\r");
31     while(RFID.available()>0)
32     {
33         char read = RFID.read();
34         serverClients[i].print(read);
35     //         delay(1);    //
36     }
37 }
38 }
39 // } //
40
41 }
```

11.17 Appendix Q: Manual Configuration of the RFID reader

```
1 void sendCommandsRFID()
2 {
3     /* send AT Commands to RFID through serial monitor */
4     //Example: AT+Scan=AC,RSSI           "Without /r"
5     while (Serial.available() > 0) {
6         RFID.write(Serial.read());
7     }
8
9 }
```

11.18 Appendix R: Communication Outlay

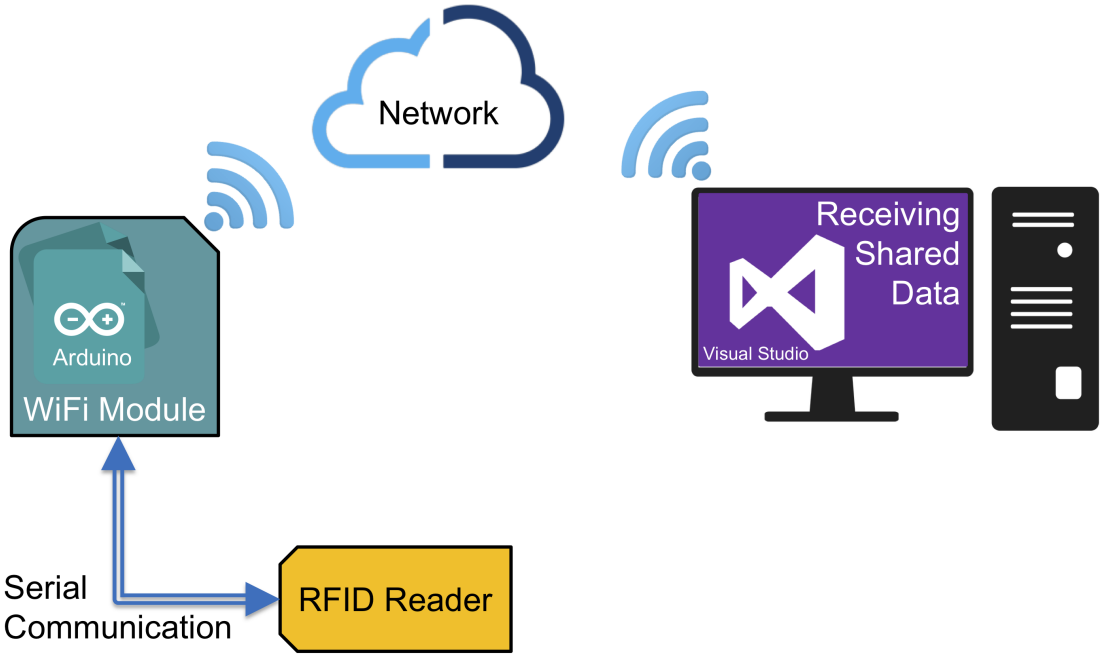

Figure 44: Communication Outlay